

# CEILINGS

All Resin Ornamentation is Flexible, Stainable & Paintable.



CEILINGS

Pearlworks, Inc. 14251 Franklin Ave. Tustin, CA 92780  
Office: (714) 573-1700 Fax: (714) 573-1708 Toll Free: (855) PEARLWORKS  
[www.pearlworksinc.com](http://www.pearlworksinc.com)

# CEILINGS



**CEIL-100B**  
17-1/4" x 20" x 1-1/4"



**CEIL-100B-EXT**  
17" x 6" x 1-1/4"

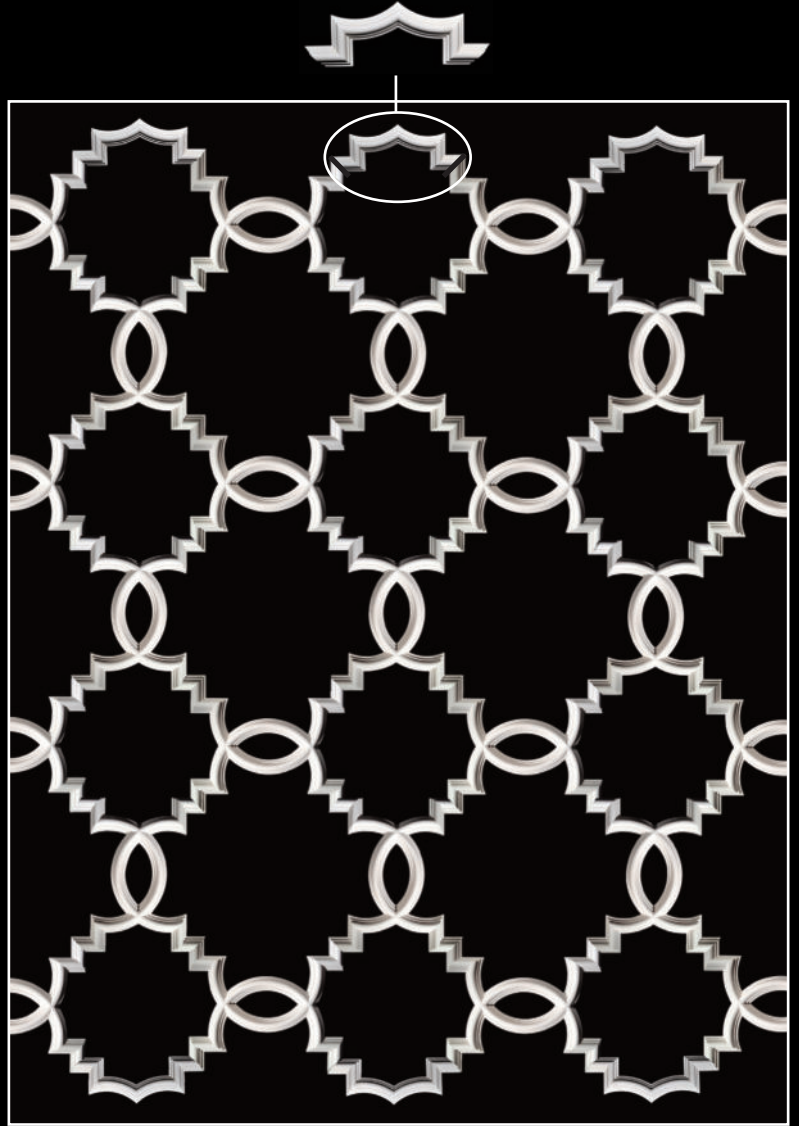

# CEILINGS

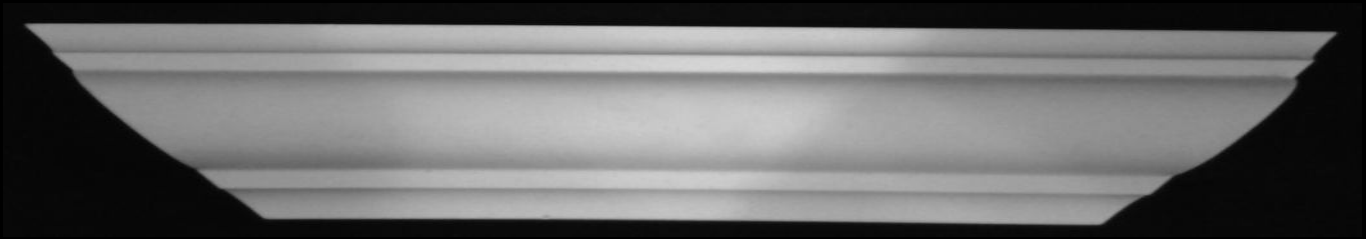

**CEIL-100-2EXT**  
10-1/2" x 2" x 1-1/4"

**CEIL-100-2EXT**

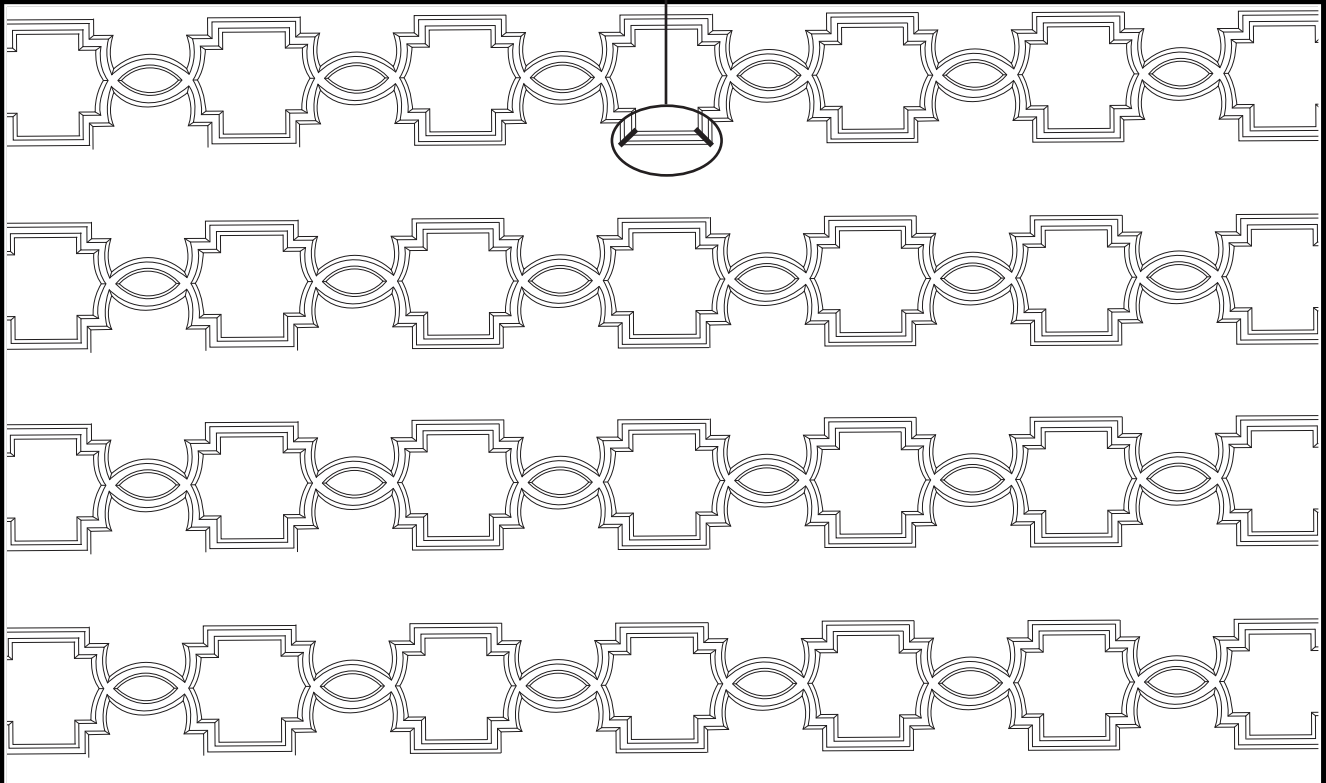

**\* Optional Design Configuration**

# CEILINGS

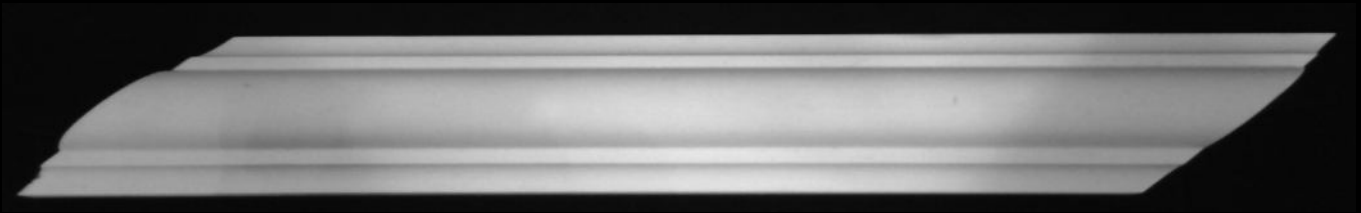

**CEIL-100-3EXT**  
12-1/2" x 2" x 1-1/4"

**CEIL-100-3EXT**

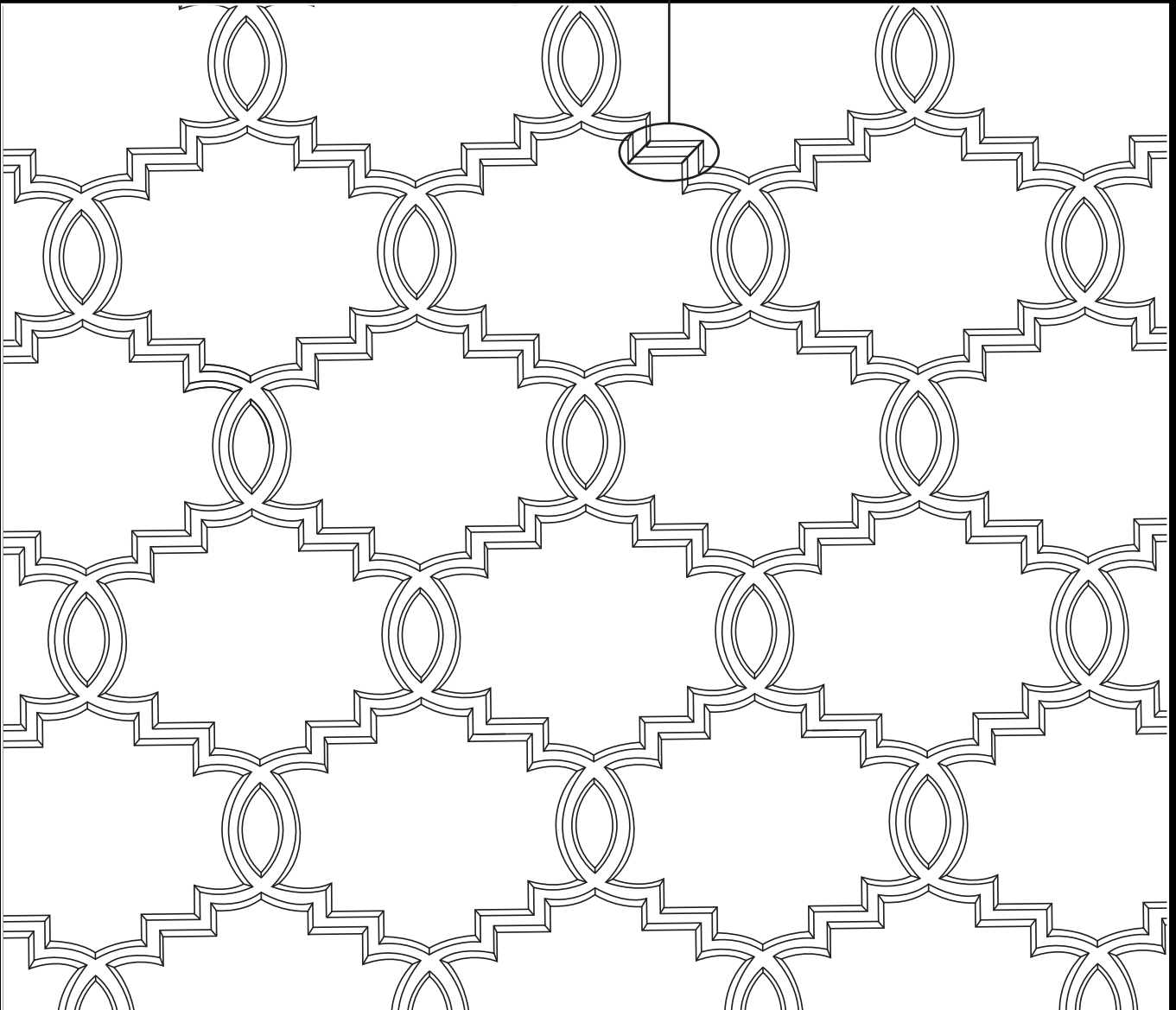

**\* Optional Design Configuration**

# CHELSEA CEILING

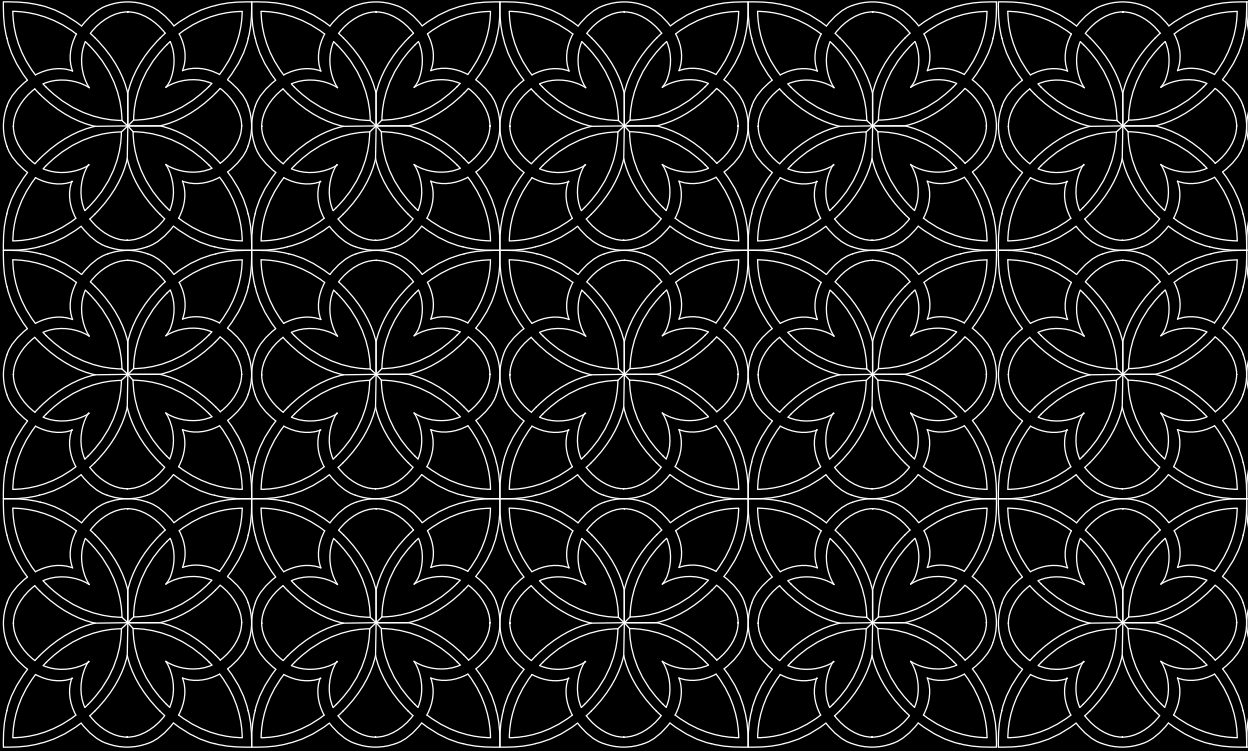
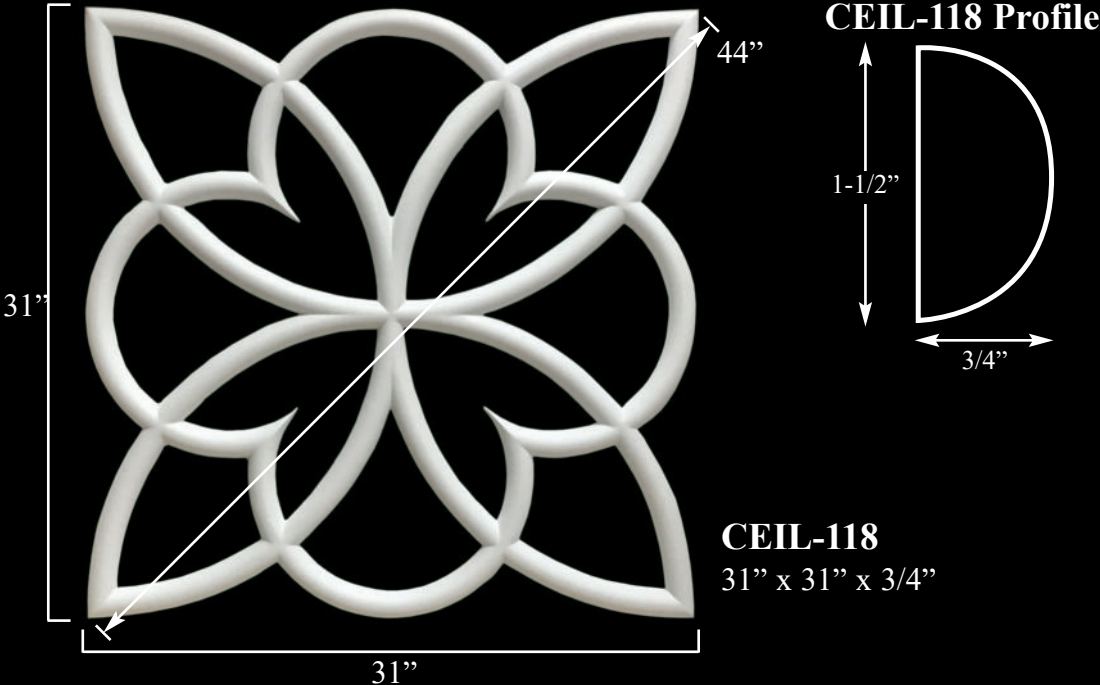

## MLD-118EC Profile

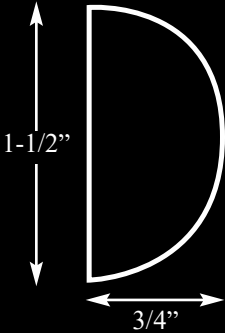

**MLD-118EC** 1-1/2" x 3/4" x 8' (MLD-118EC matches CEIL-118 profile.)

\* All sizes are approx. - max W" x max H" x Thickness"

# DHALIA CEILING

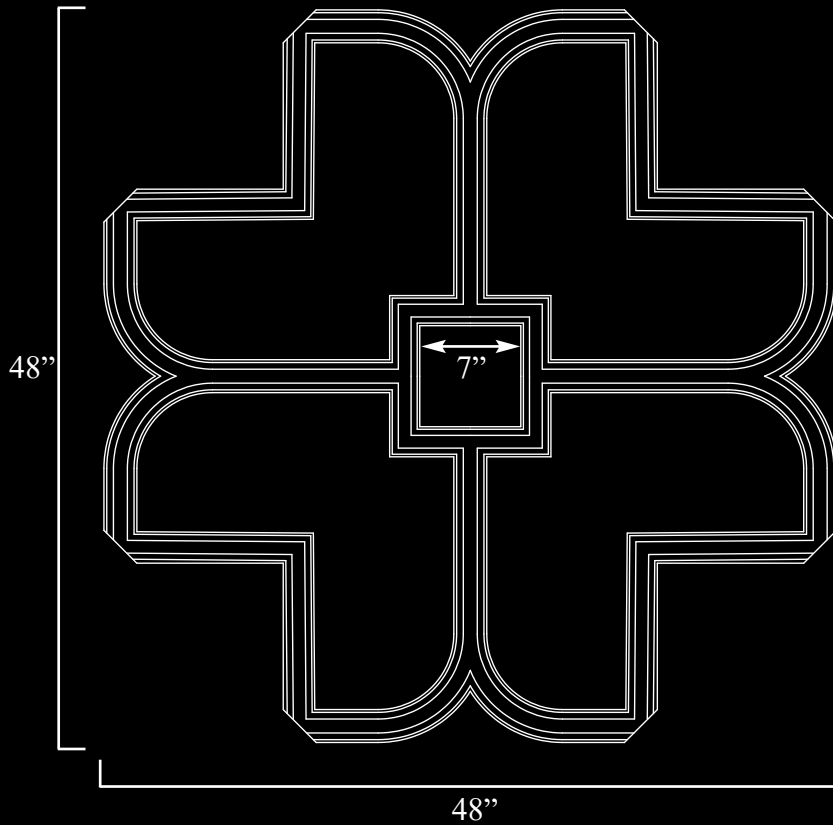

**CEIL-119 Profile**

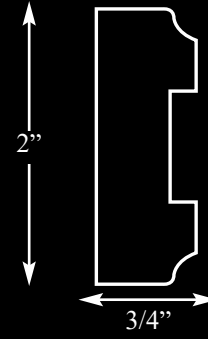

**CEIL-119**

48" x 48" x 3/4"

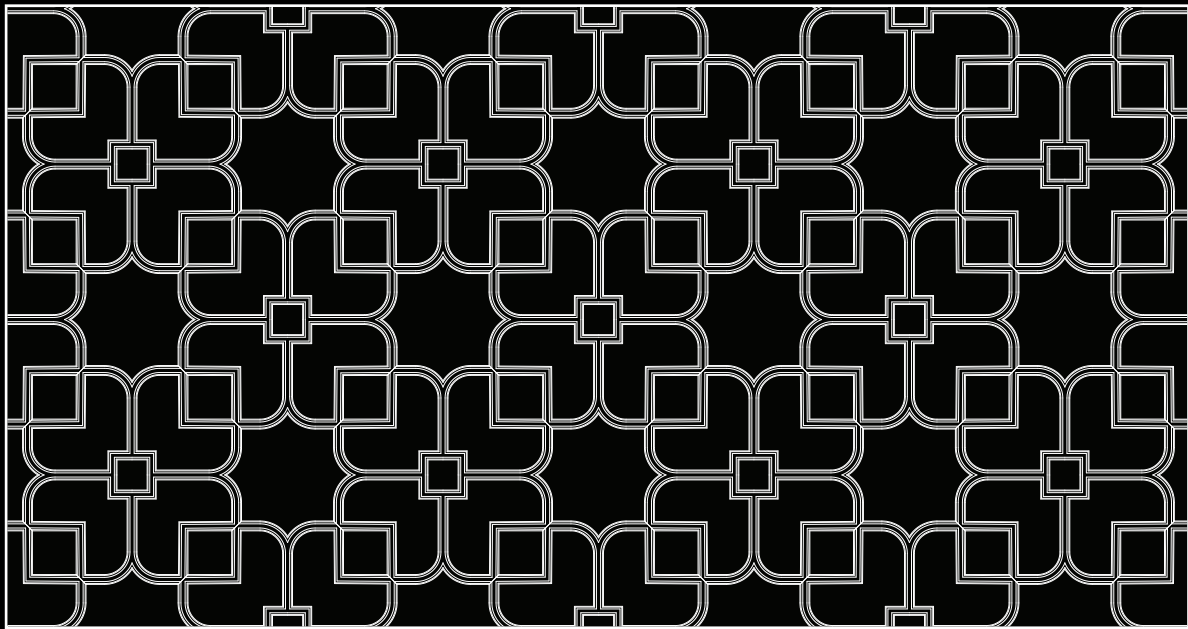

**MLD-259 Profile**

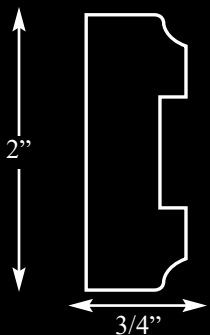

**\* CEIL-119 can be modified with MLD-259.**



**MLD-259** 2" x 3/4" x 10' (MLD-259 matches CEIL-119 profile.)

# CEILINGS



**CEIL-120**

16-1/2" x 16-1/2" x 6-1/2"



**CEIL-122**

16-1/2" x 16-1/2" x 3-1/2"



CEILINGS

Variation of Gagnard Ceiling Pattern using different Trims & Center Panels.

\* All sizes are approx.- max W" x max H" x Thickness"

# CEILINGS



**CEIL-123A**

16-3/4" x 16-3/4" x 2"  
2-1/2" Bore for sprinkler  
Shown with optional  
**RING-123B & FIN-120**

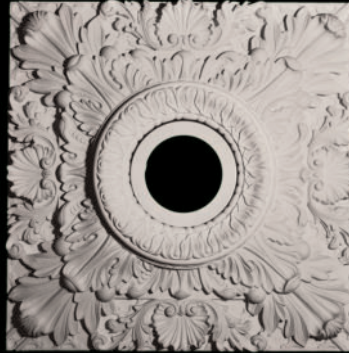

**CEIL-123B**

16-3/4" x 16-3/4" x 2"  
4-1/2" Bore for 4" recessed light  
Shown with optional  
**RING-123B**



**CEIL-123C**

16-3/4" x 16-3/4" x 2"  
6-1/2" Bore for 6" recessed light  
Shown with optional  
**RING-123C**



**Light ring**  
**RING-123B**



**Light ring**  
**RING-123C**



**ROST-120**



**FIN-120**  
Shown w/optional  
**ROST-120**



Shown with all parts assembled.

## Ceiling 123 components:

Pearlworks has developed a new system using multiple size rings and a revolutionary finial designed for use with fire sprinklers to increase the versatility of our ceiling tiles.

- 1) The CEIL-123A series ceiling tile with RING-123B fits our FIN-120 finial, which is bored to fit standard concealed fire sprinkler heads (2 1/2 inches) as well as made to the exact length to position the head for adequate water dispersion according to uniform fire code.
- 2) Use CEIL-123A with RING-123B and FIN-120 in locations without sprinkler heads and our ROST-120 provides a perfect cap while hiding the bore in the finial.
- 3) When installing 4 inch recessed lighting CEIL-123B is used, the finial is eliminated, and RING-123B hides the standard trim rings.
- 4) When installing 6 inch recessed lighting CEIL-123C is used, the finial is eliminated, and RING-123C hides the standard trim rings.



# CEILINGS

Design #1



**CEIL-164A**  
15" x 15" x 7/8"



**CEIL-164B**  
36" x 48" x 7/8"

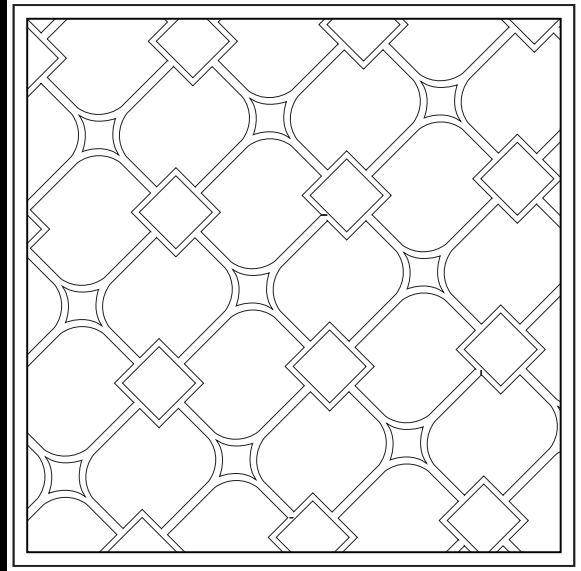

Design #2



**CEIL-164D**  
22" x 22" x 7/8"



**CEIL-164E**  
17" x 17" x 7/8"

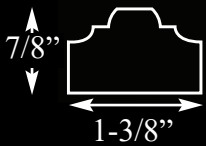

**MLD-164**  
1-3/8" x 7/8" x 10'

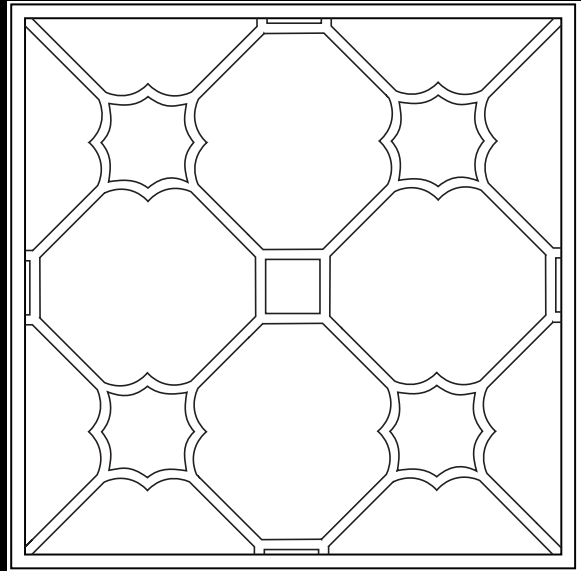

Design #3

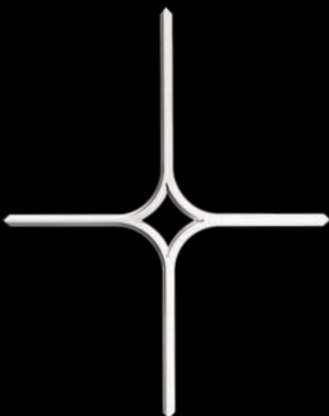

**CEIL-164B**  
36" x 48" x 7/8"



**CEIL-164C**  
17" Dia. x 7/8"

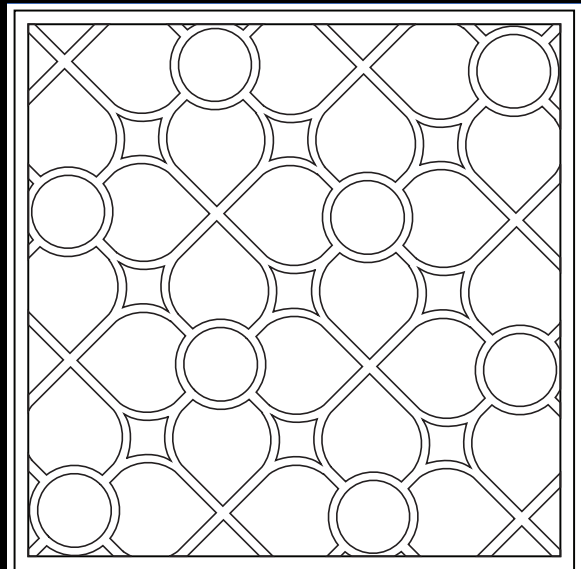

CEILINGS

\* All sizes are approx.- max W" x max H" x Thickness"

# CEILINGS

We recommend a standard 2" x 4" or 2" x 6" wood studs.

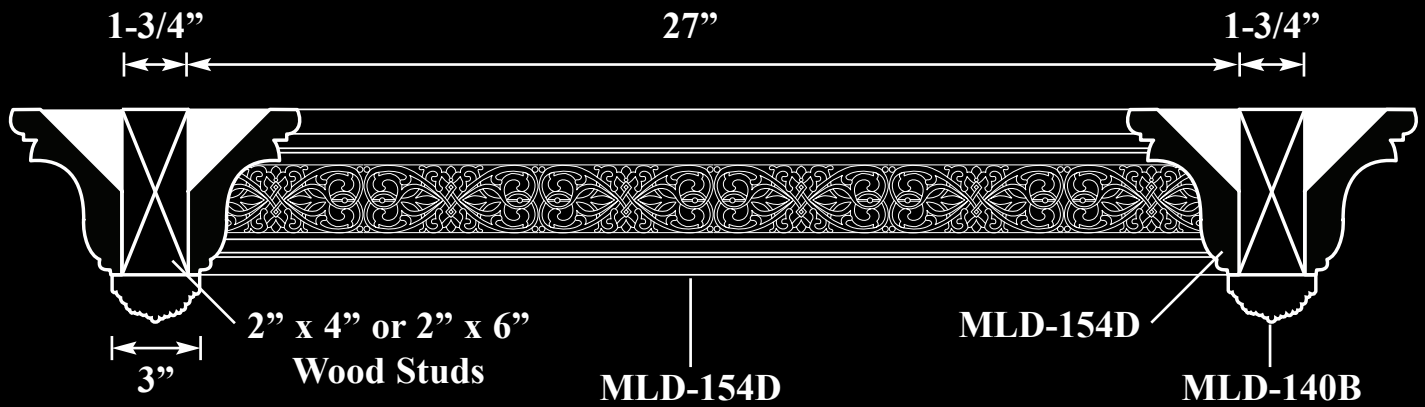

# CEILINGS

By assembling four pieces of Pearlworks crown moulding together in a square, attaching a piece of plywood to the top, and nailing a 1/2 in. x 1/2 in. wood strip around the perimeter, a decorative ceiling tile can be easily created to convert conventional suspended T-bar and tiles into a luxurious coffered ceiling. This method of construction greatly reduces the labor costs associated with custom installation, as well as providing the versatility and accessibility of the suspended ceiling.

See our Conceptual Line Drawing Catalogs for additional designs.

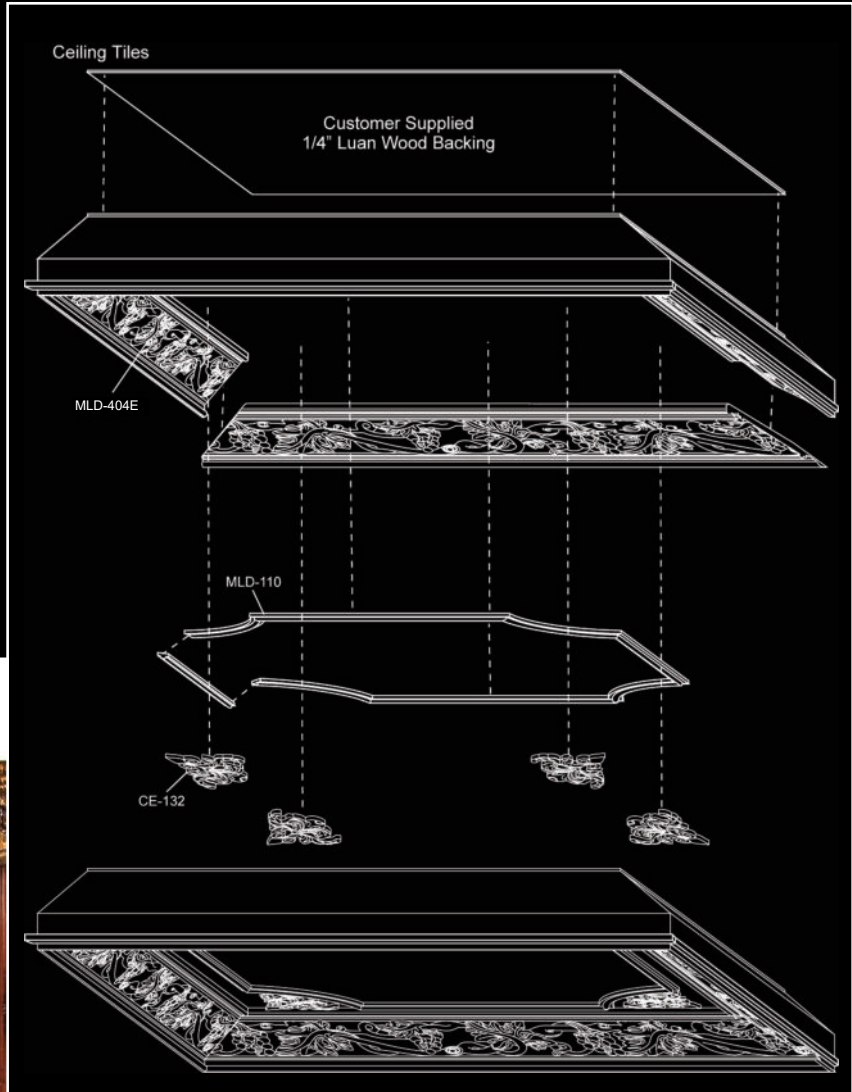

\* Ceiling shown with optional designs for multiple looks.

\* All sizes are approx.- max W" x max H" x Thickness"

# CEILINGS



**CEIL-401**

Sold as a 3 piece set  
14-1/2" x 14-1/2" x 2"



**CEIL-402**

Sold as a 3 piece set  
25-1/2" x 25-1/2" x 2"

# Square Ceiling 110-1

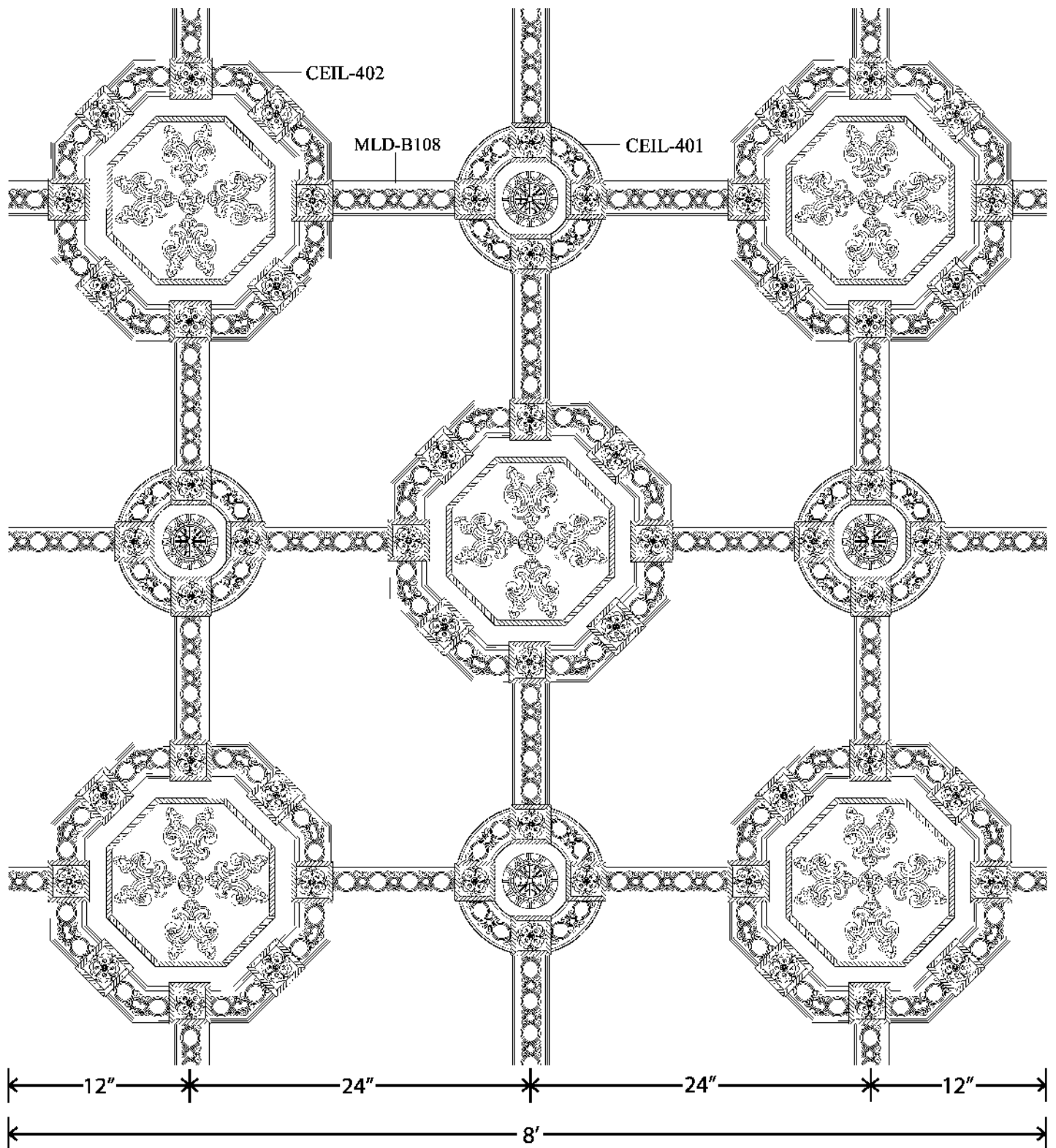

The pattern of these ceiling tiles can be manipulated to fit rooms in a variety of shapes and sizes. The most important part of establishing layout is avoiding partial tiles at the intersection between the wall and ceiling. Using the layout described above the estimated starting price for Pearlworks parts run approximately **\$29** per square foot.

# CEILINGS

All Resin Ornamentation is Flexible, Stainable & Paintable.



This spectacular barrel vaulted ceiling can add a palatial look to any room or hallway. While inherently complex, Pearlworks' flexible parts make this ceiling not only feasible, but easy. The plywood trusses and "wobble wood" shell can be easily retrofitted in any room with adequate ceiling height. The amount of curve can be manipulated to accommodate for different ceiling heights and room sizes. Once the desired grid layout is established the remainder of the installation is relatively simple. Proper layout is essential for placement of both ornamentation and lighting fixtures. Layout consultation is available upon request.

Parts used: MLD-212F, PANL-130, OL-145, PB-292B, ROST-101, SW-127A, FIN-102, MLD-250, MLD-154D.

# Radius Ceiling 105-4

FSD-19AA  
48" Wide x 20" High  
FSD-19A (Shown in Drawing)  
52" Wide x 30" High  
FSD-19B  
68" Wide x 27" High

PANL-105A

FSD-87A  
80" Dia.

MLD-216A

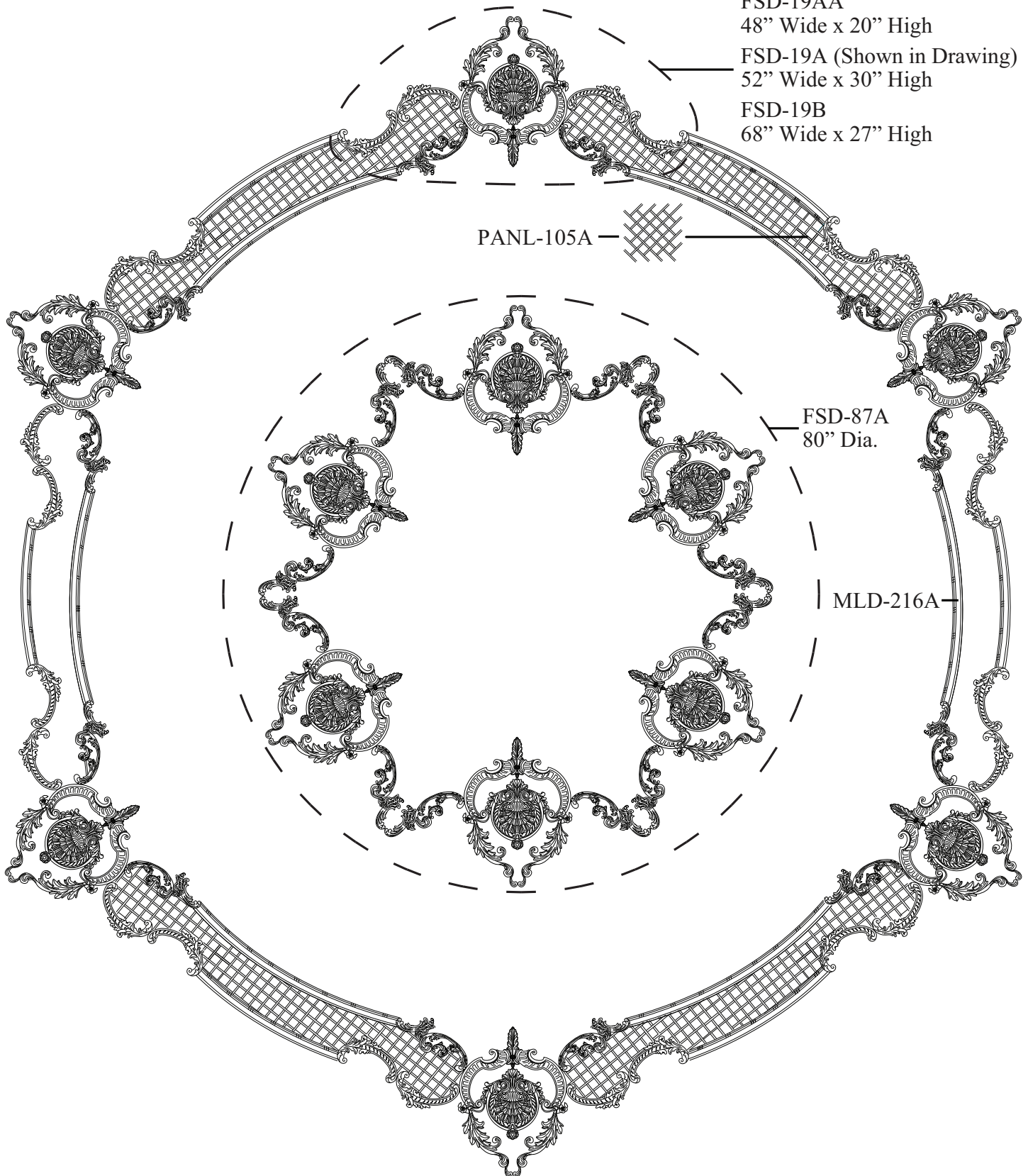



Toll Free: (855)-PEARLWORKS Website: pearlworksinc.com

Rectangular Ceiling 118-1

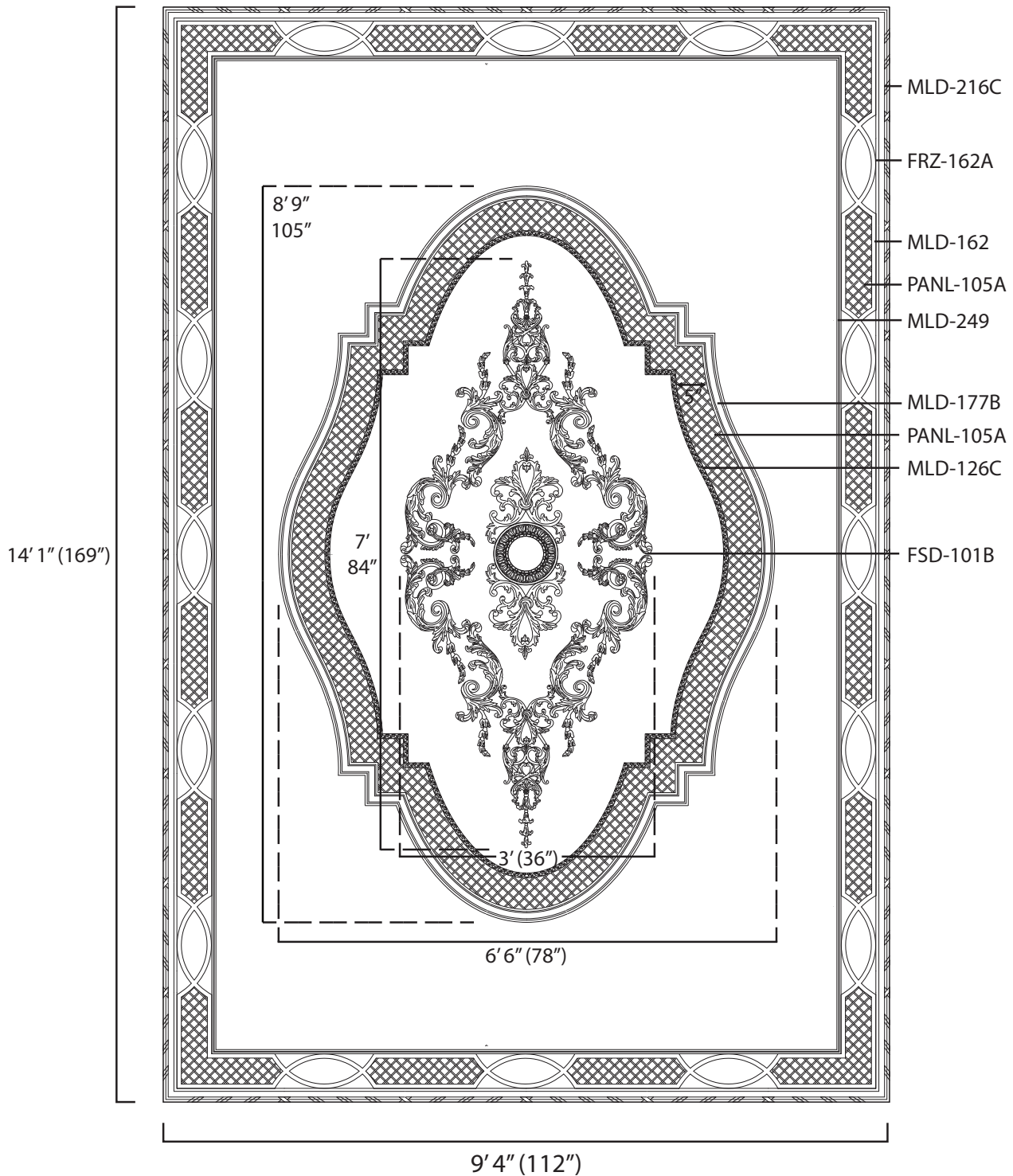

\*"THIS IS NOT A BUILD DRAWING". All drawings are "CONCEPT ONLY" and should be used as such.

\*Projects built from concept drawings will "ALWAYS" vary due to unforeseen installation and field measurement changes.



# Square Ceiling 101-2

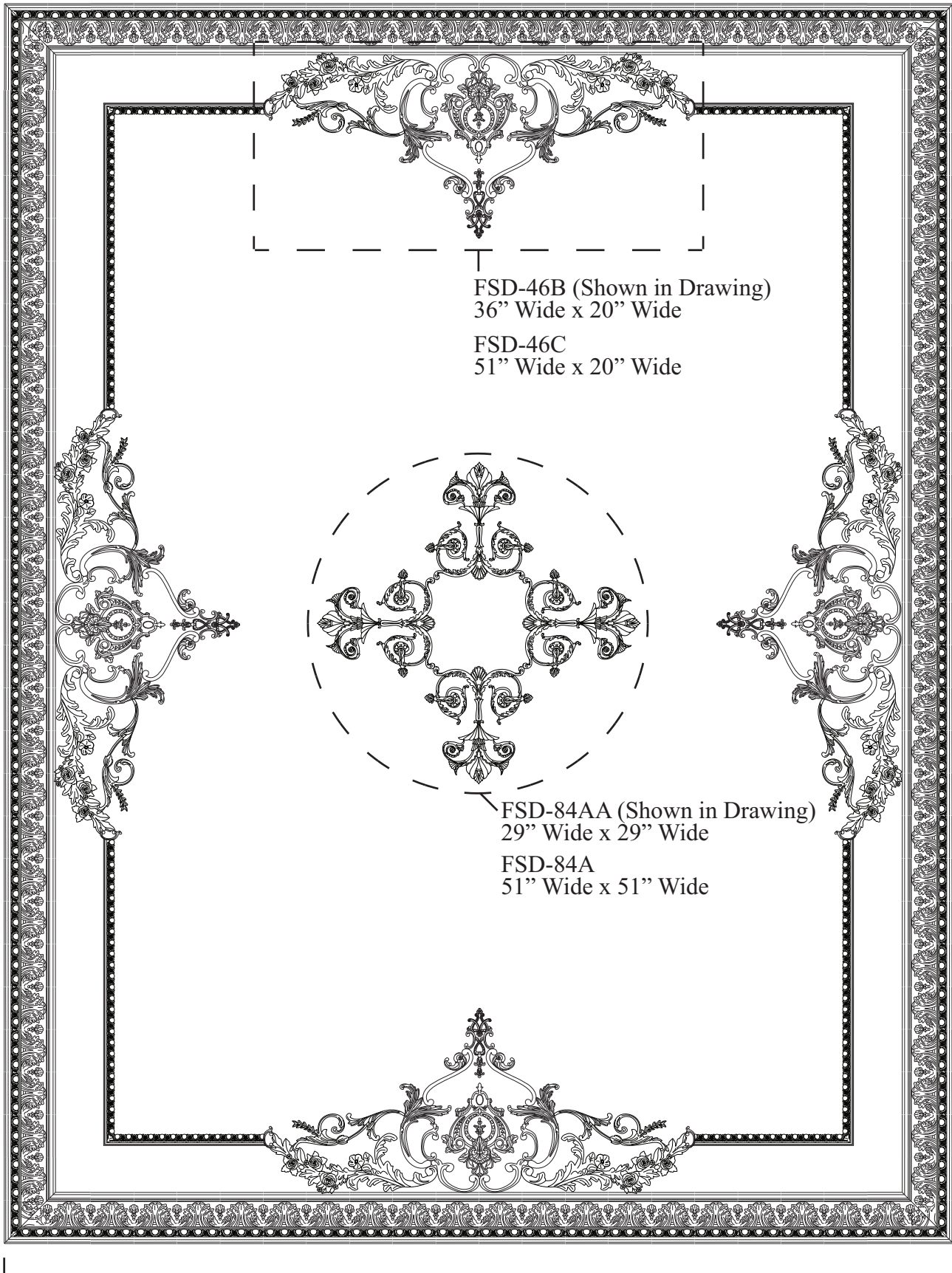

10'

6'7"

# Radius Ceiling 103-8

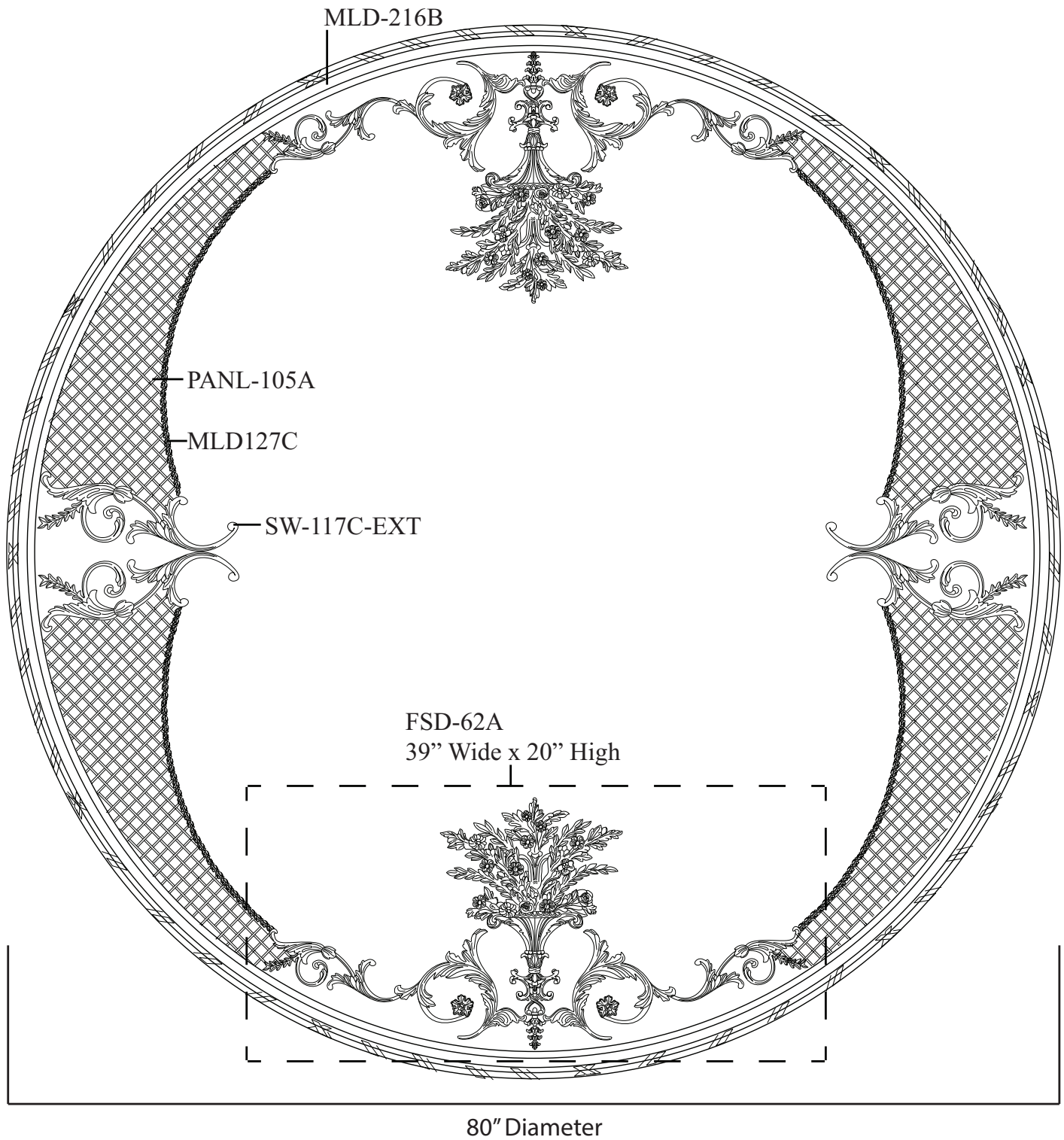

# Square Ceiling 107-1

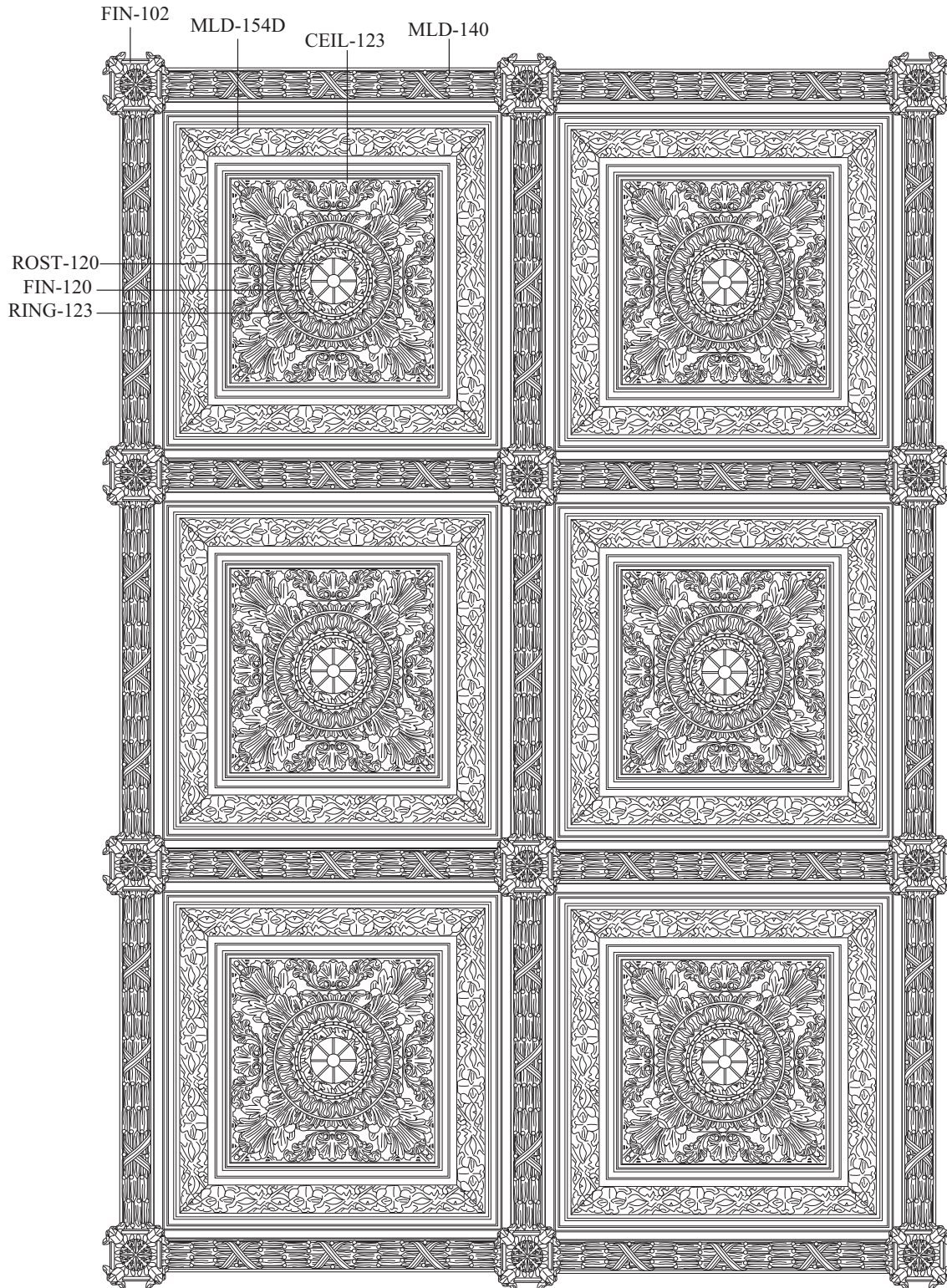

This beautifully detailed ceiling has been engineered for easy installation in a variety of applications. Our modular panels and rings are designed to accommodate 4 & 6 inch recessed lighting and our finials allow for installation of fire sprinklers at the perfect position for water dispersion as per uniform fire code. The cost of parts for this ceiling varies greatly depending on size and layout, but the estimated starting cost for pearlworks parts as shown is approximately \$3850, or \$110 per square foot.

# CEILINGS

**All Resin Ornamentation is Flexible, Stainable & Paintable.**



This Ceiling was built by using a distressed construction grade lumber grid for an “Old World” look. The diagonal pattern can be adjusted to install in any size room and is a perfect choice when ceiling height is an issue. At an overall thickness of 1.5 inches, this detail provides plenty of depth. The only Pearlworks part used is PANL-116B.

# T-BAR CEILING!



**This Ceiling was designed using the commercial style T-Bar Drop Ceiling Grid System. A very simple and inexpensive way to build the classic coffered ceiling.**

# CEILINGS



# CEILINGS

## Radius Ceiling 101-8

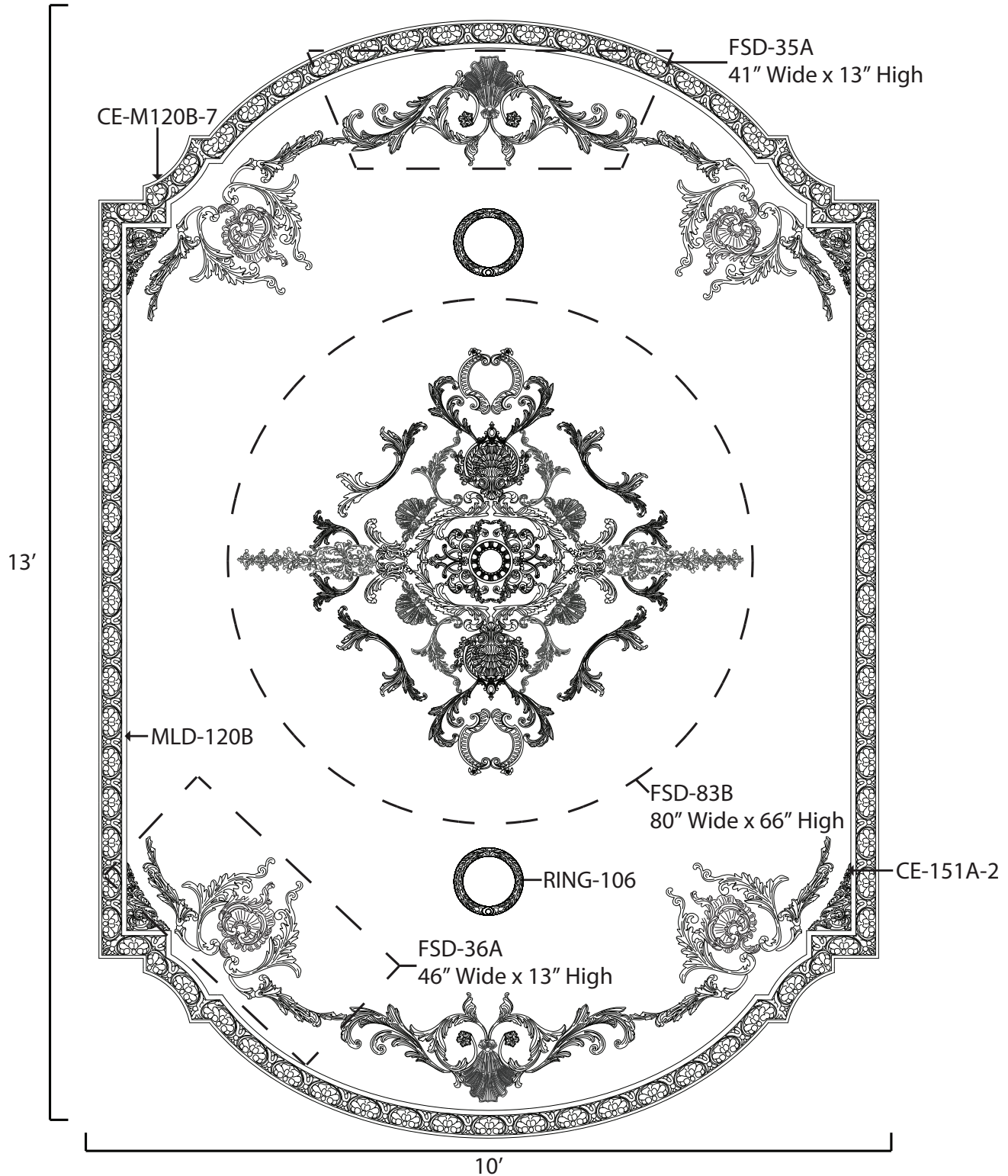

CEILINGS

# CEILINGS

All Resin Ornamentation is Flexible, Stainable & Paintable.





# CEILINGS

All Resin Ornamentation is Flexible, Stainable & Paintable.



CEILINGS

# CHELSEA CEILING

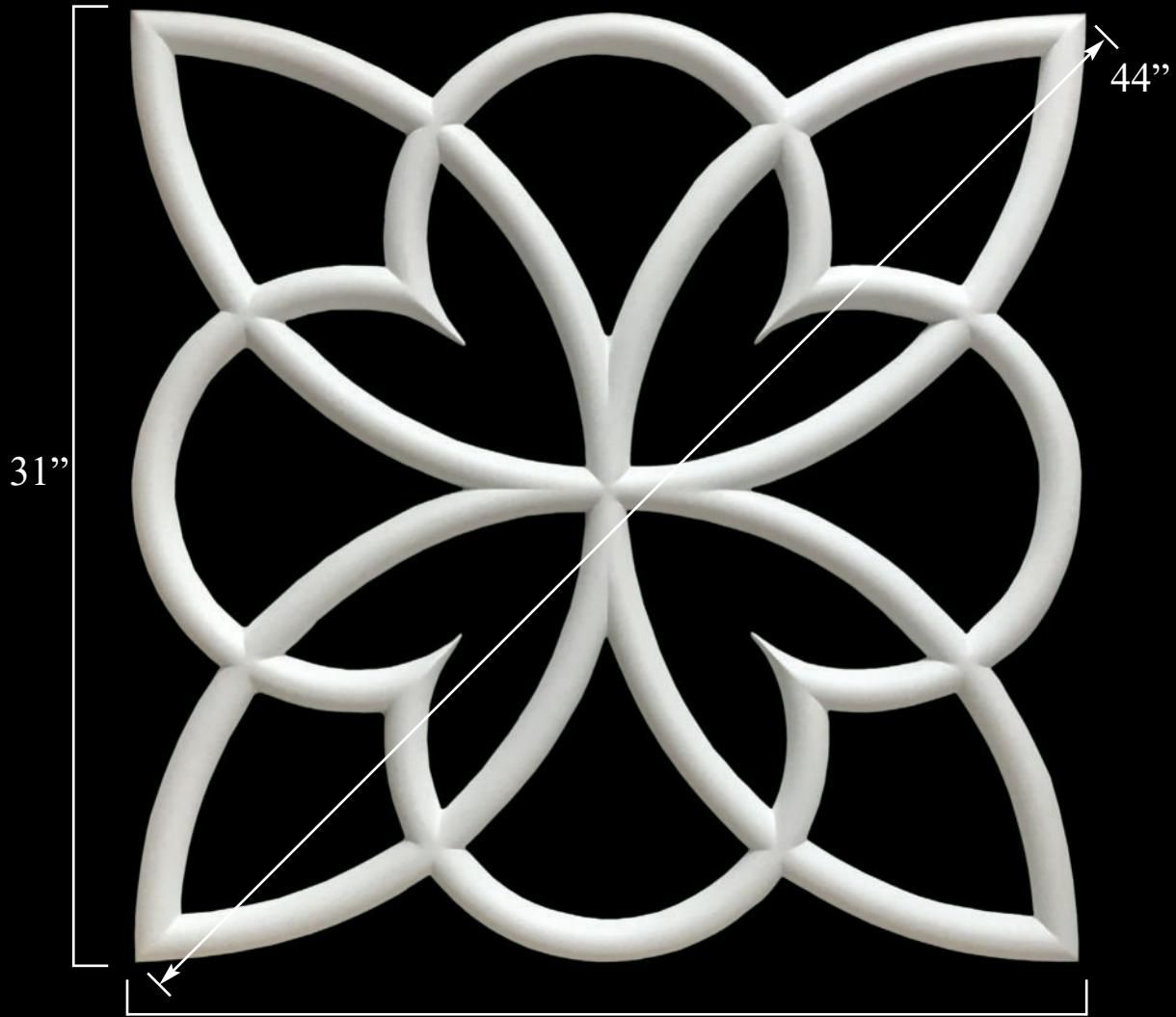

31"

**CEIL-118**

31" x 31" x 3/4"

**MLD-118EC Profile**

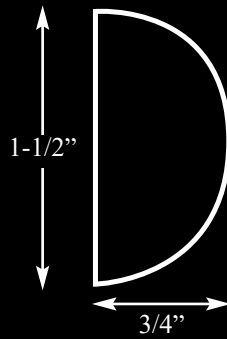

**CEIL-118 Profile**

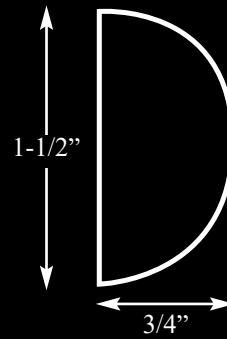

**MLD-118EC** 1-1/2" x 3/4" x 8' (MLD-118EC matches CEIL-118 profile.)

# CHELSEA CEILING

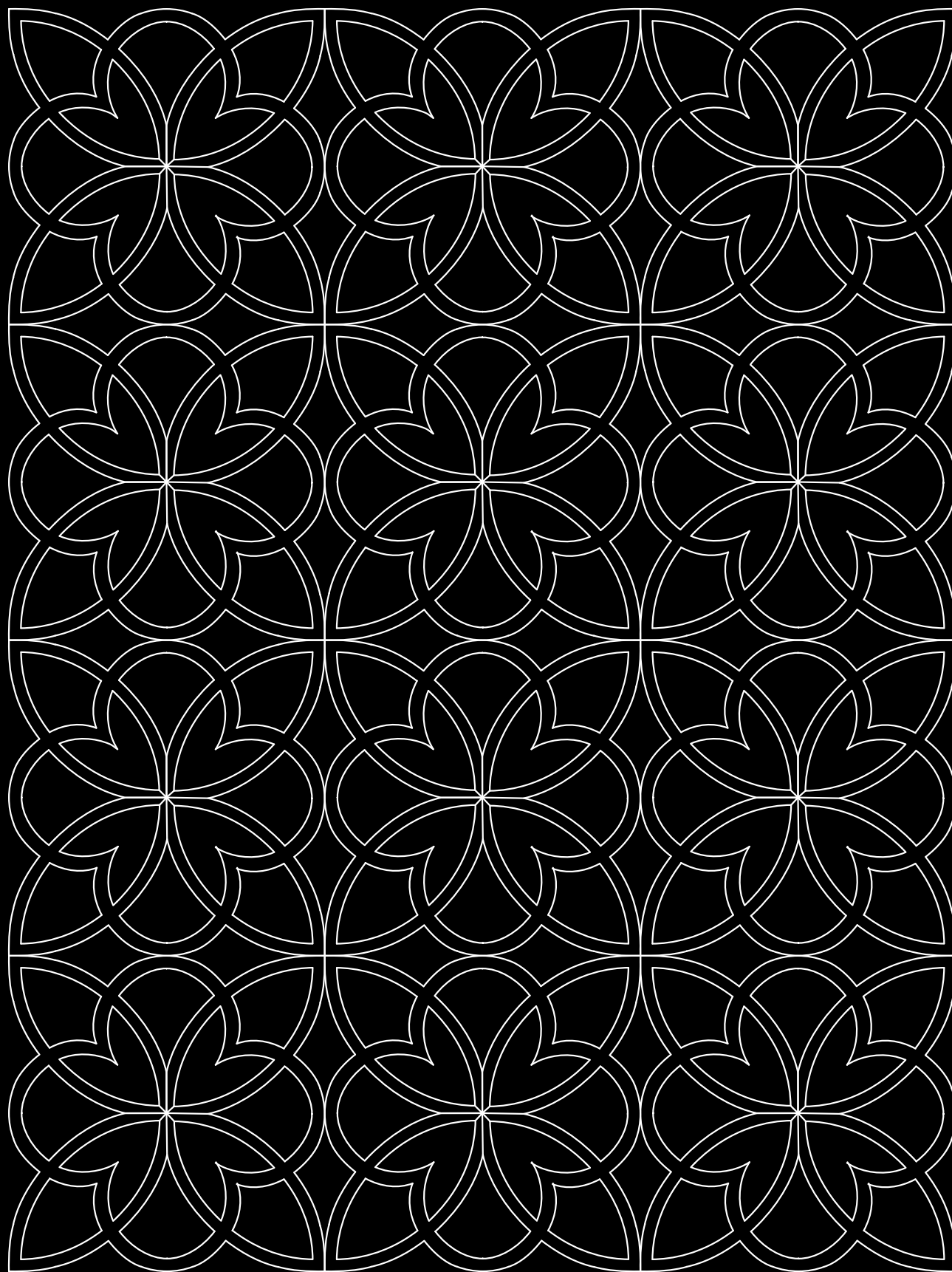

\* All sizes are approx.- max W'' x max H'' x Thickness''

# DHALIA CEILING

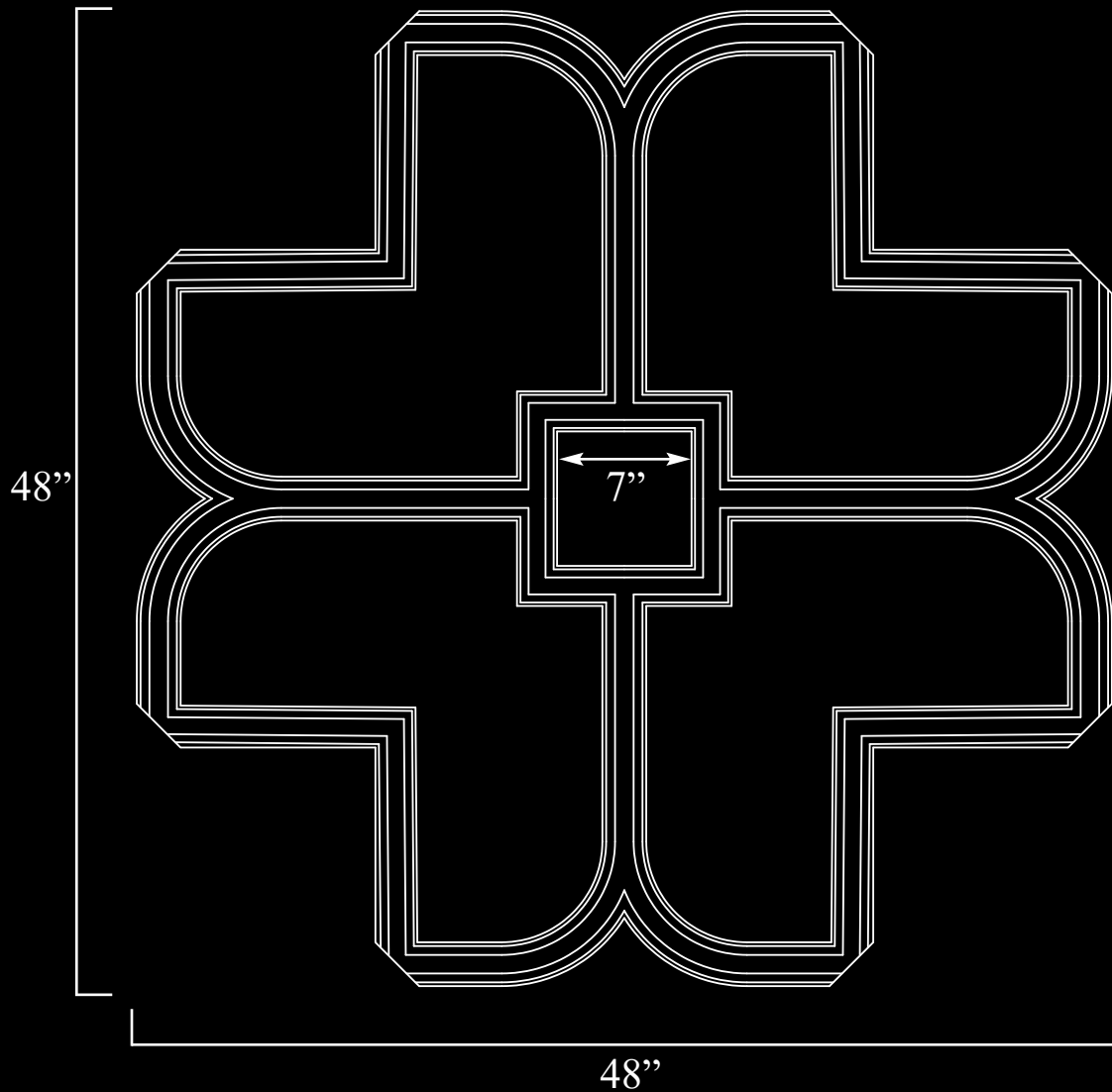

**CEIL-119**

48" x 48" x 3/4"

**MLD-259 Profile**

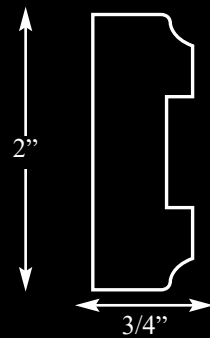

**CEIL-119 Profile**

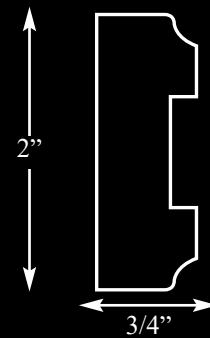

**\*CEIL-119 can be modified with MLD-259.**



**MLD-259** 2" x 3/4" x 10' (MLD-259 matches CEIL-119 profile.)

# DHALIA CEILING

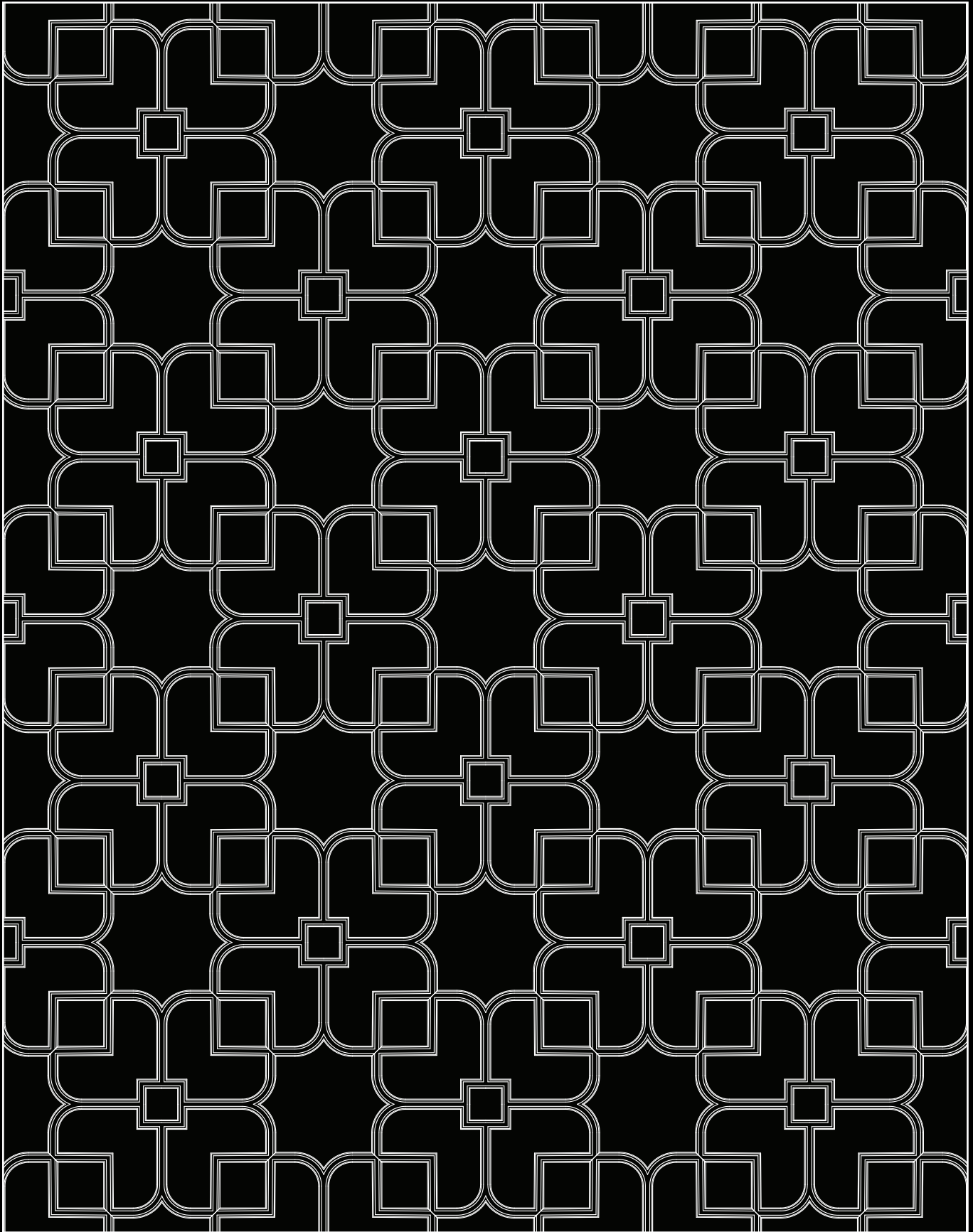

# CEILINGS



**Chaplin Ceiling Series 3 Variation 3**

**Chaplin Ceiling Series 1 Variation 1**

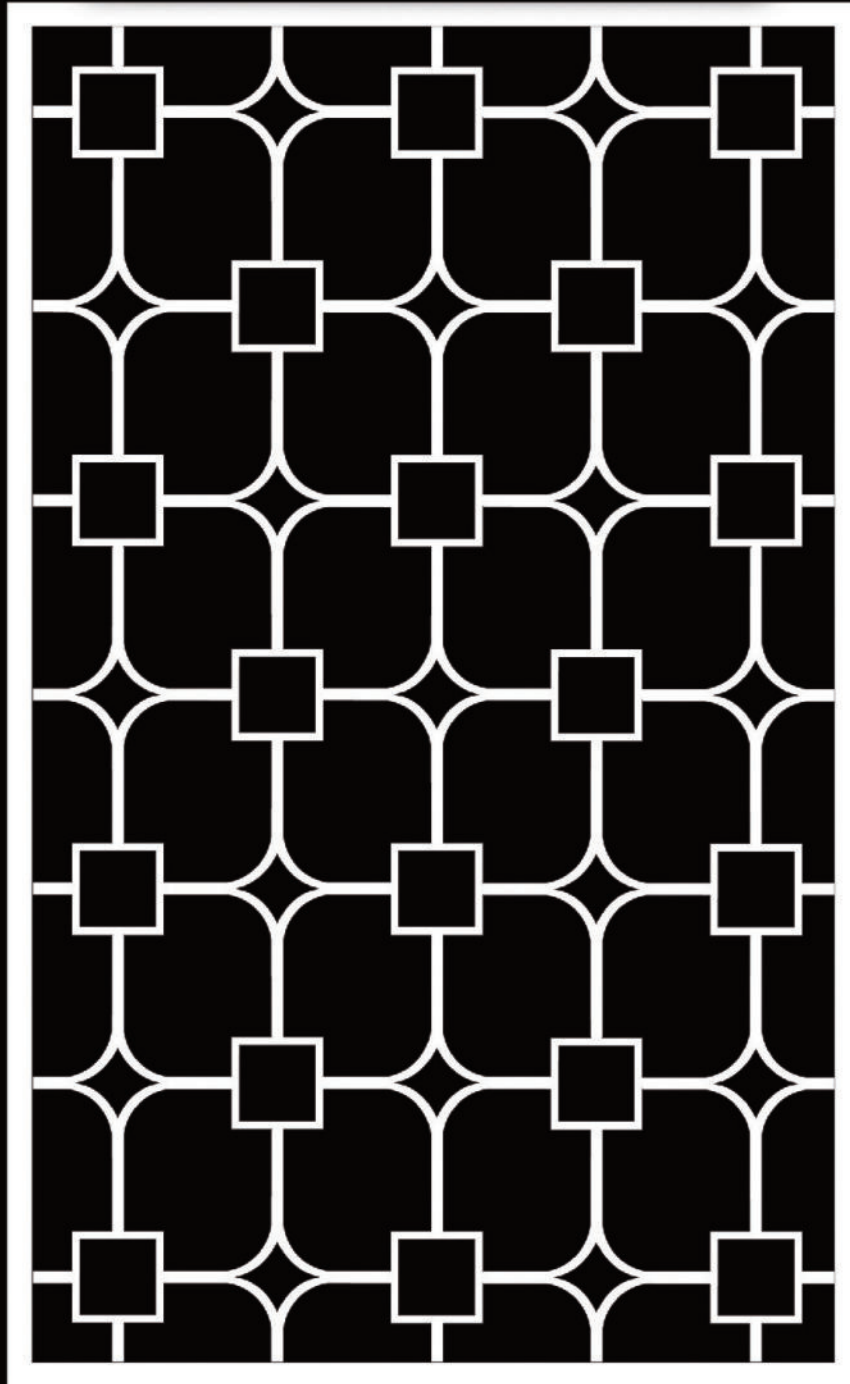

*Introducing the*  
**CHAPLIN CEILING COLLECTION**

# CHAPLIN CEILING

# SERIES 1

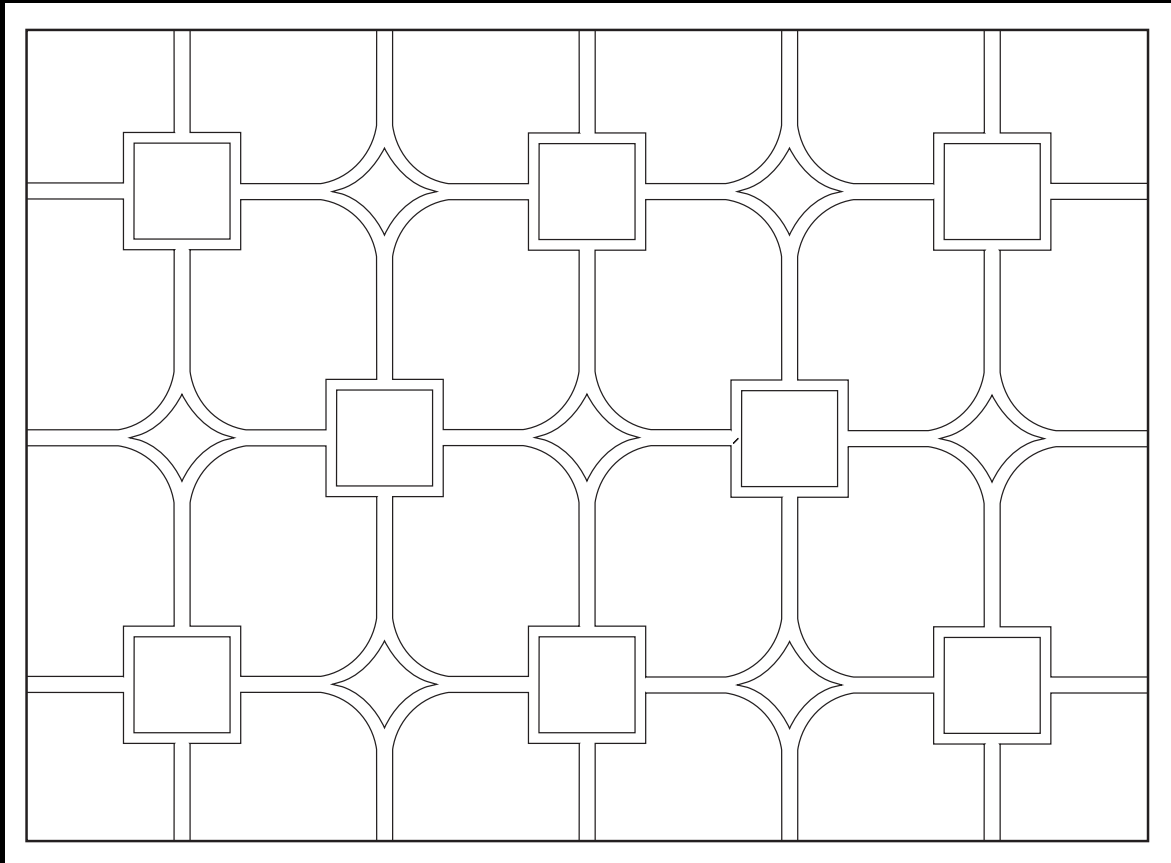

The PEARLWORKS CHAPLIN CEILING was designed using only two components that are both flexible and adjustable. This is the only ceiling on the market that offers these unique features.

**FLEXIBILITY:** Let's talk about the flexibility of our product. Unlike plaster ceilings that are rigid and brittle, PEARLWORKS flexible ceiling components are both pliable and durable. Why is this important? Shorter and easier Installation times. Just Imagine being able to install this ceiling to curved surfaces at no additional cost or time! Something that is both difficult and expensive to do in plaster.

**INSTALLATION:** I have never seen a drywall or plaster ceiling that was perfectly flat! PEARLWORKS flexible ceilings components give a tighter fit for imperfect ceiling surfaces. Typically Flexible ceiling installations require 60 to 70 percent less time.

**MATERIAL COST:** Depending on who you are buying your plaster ceiling from, Pearlworks flexible ceilings are very competitively priced. Imagine..... Less material cost, less installation time, infinite design possibilities and most importantly we have all ceilings in stock.

**SHIPPING AND PACKAGING COST:** Because plaster is a more brittle product, breakage in shipping is more likely to occur. Packaging plaster products is also more expensive and time consuming.

**DESIGN OPTIONS:** Pearlworks offers multiple variations within each ceiling pattern. Additionally, optional carving details can be added to the ceiling offering hundreds of different looks. This flexibility allows our customers to custom match every detail to match exactly the look they want. Pearlworks is the only manufacturer in the world presently offering this feature.



**Series 1**

**Variation 1**

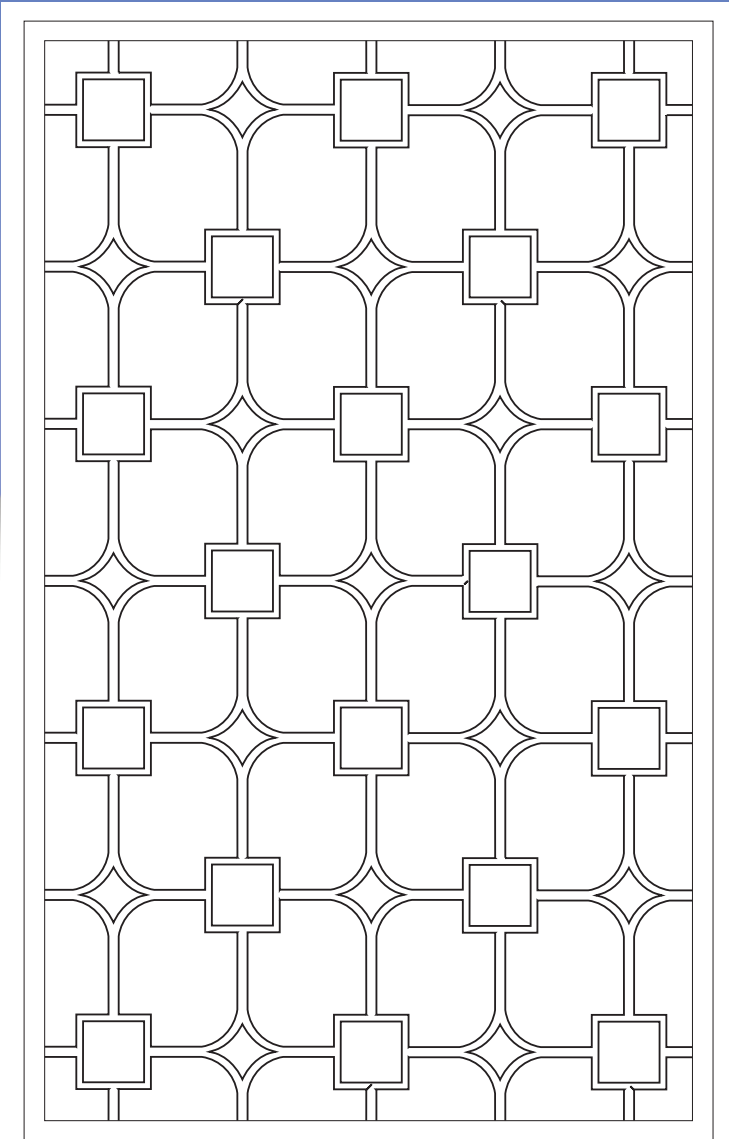

**FLEXIBLE CHAPLIN  
CEILING PATTERN**

- Flexible material for flat or curved ceilings.
- All modular ceilings can easily be modified to create many new designs. (Call for info. Multiple patterns available).
- Quicker & easier installation vs plaster ceilings.
- Does not require specialized installers.
- Material can be stained or painted.

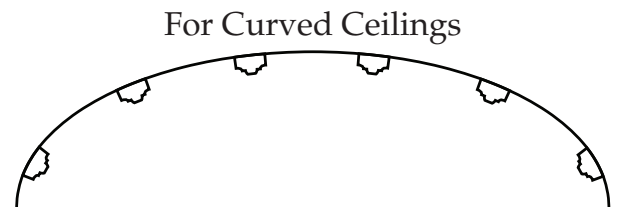

MLD-164

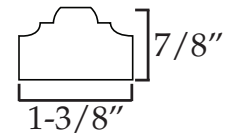

Moulding Profile of Chaplin Ceiling

CEIL-164B

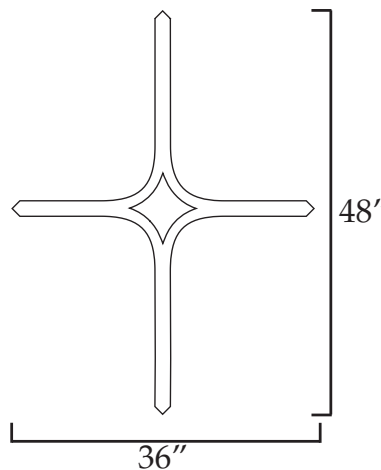

CEIL-164A

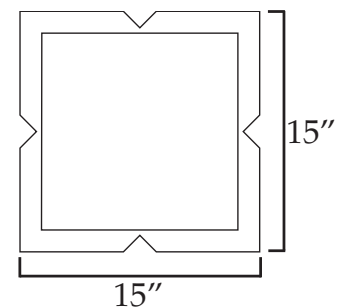

# CHAPLIN CEILING VARIATIONS

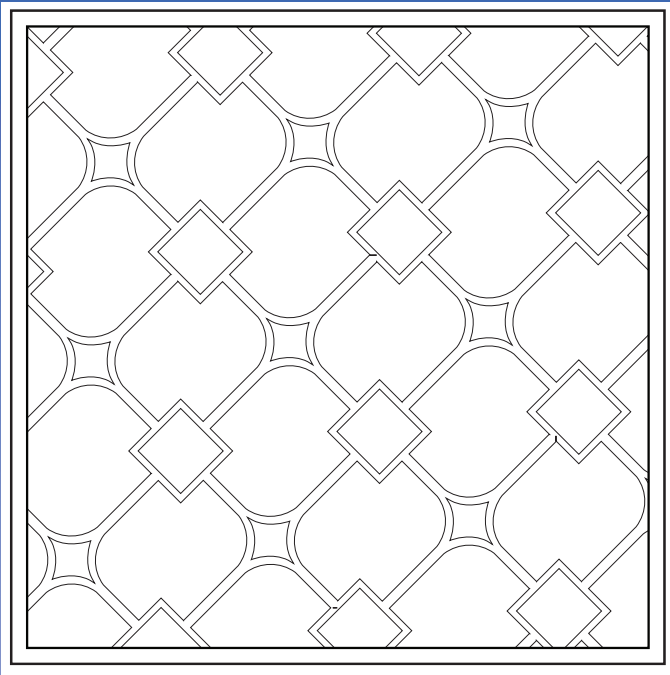

Series 1

Variation 2

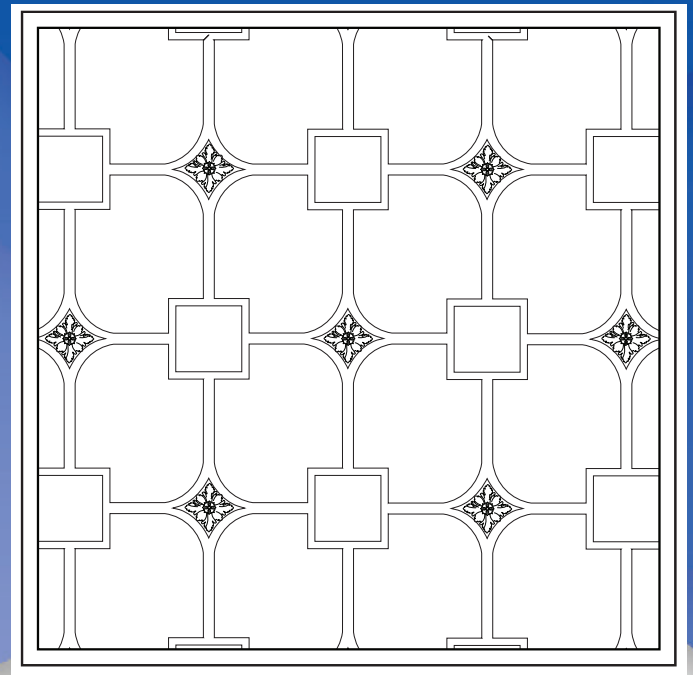

Series 1

Variation 3

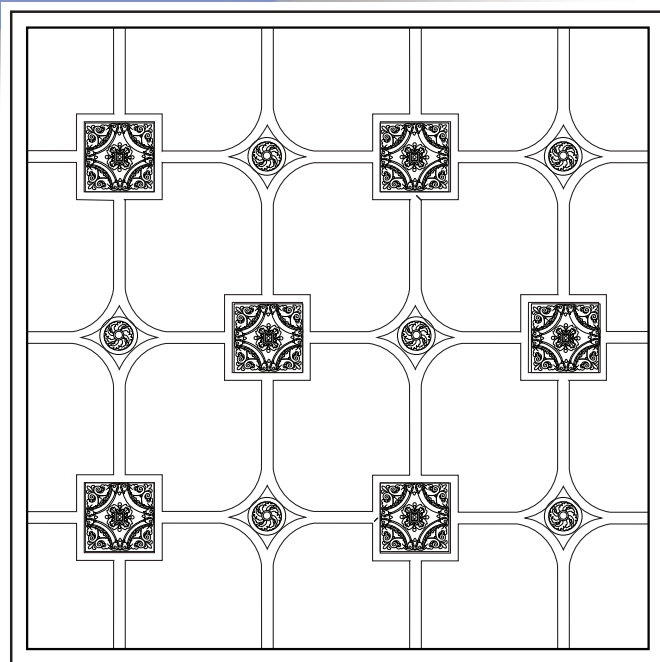

Series 1

Variation 6

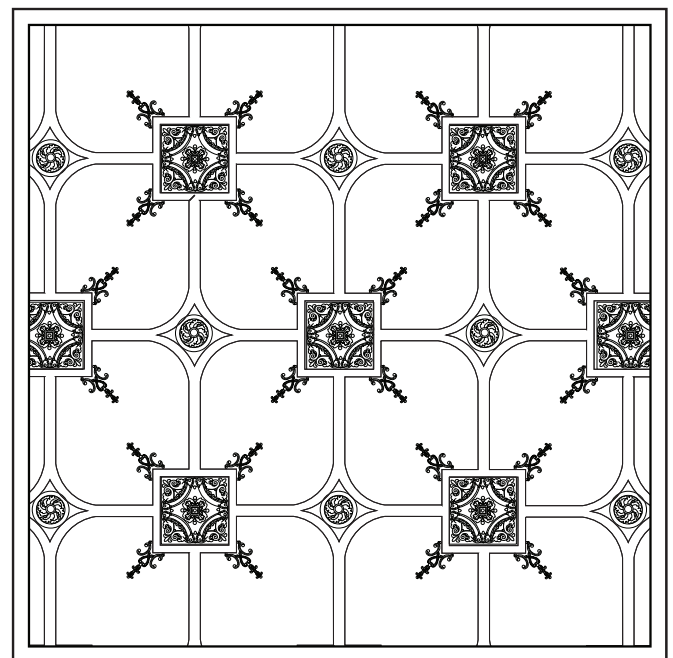

Series 1

Variation 7

Call Pearlworks for Details!

# CHAPLIN CEILING

# SERIES 3

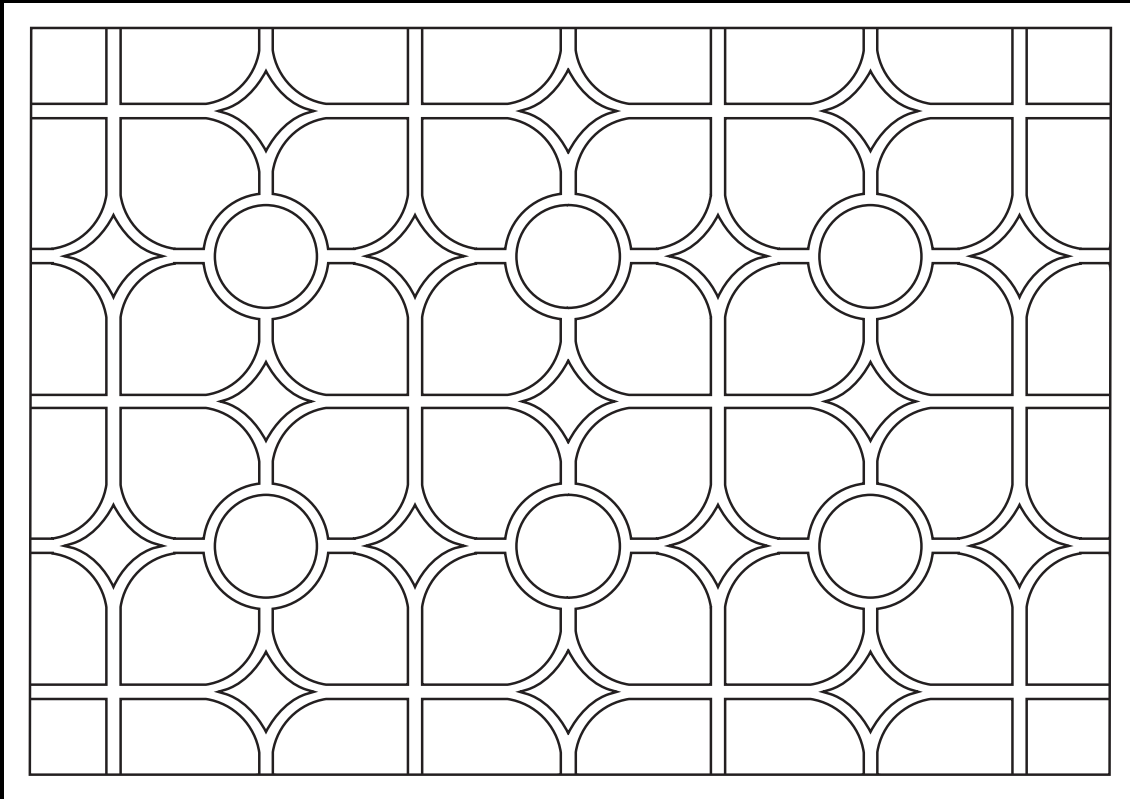

The PEARLWORKS CHAPLIN CEILING was designed using only two components that are both flexible and adjustable. This is the only ceiling on the market that offers these unique features.

**FLEXIBILITY:** Let's talk about the flexibility of our product. Unlike plaster ceilings that are rigid and brittle, PEARLWORKS flexible ceiling components are both pliable and durable. Why is this important? Shorter and easier Installation times. Just Imagine being able to install this ceiling to curved surfaces at no additional cost or time! Something that is both difficult and expensive to do in plaster.

**INSTALLATION:** I have never seen a drywall or plaster ceiling that was perfectly flat! PEARLWORKS flexible ceilings components give a tighter fit for imperfect ceiling surfaces. Typically Flexible ceiling installations require 60 to 70 percent less time.

**MATERIAL COST:** Depending on who you are buying your plaster ceiling from, Pearlworks flexible ceilings are very competitively priced. Imagine..... Less material cost, less installation time, infinite design possibilities and most importantly we have all ceilings in stock.

**SHIPPING AND PACKAGING COST:** Because plaster is a more brittle product, breakage in shipping is more likely to occur. Packaging plaster products is also more expensive and time consuming.

**DESIGN OPTIONS:** Pearlworks offers multiple variations within each ceiling pattern. Additionally, optional carving details can be added to the ceiling offering hundreds of different looks. This flexibility allows our customers to custom match every detail to match exactly the look they want. Pearlworks is the only manufacturer in the world presently offering this feature.

**Series 3**

**Variation 1**

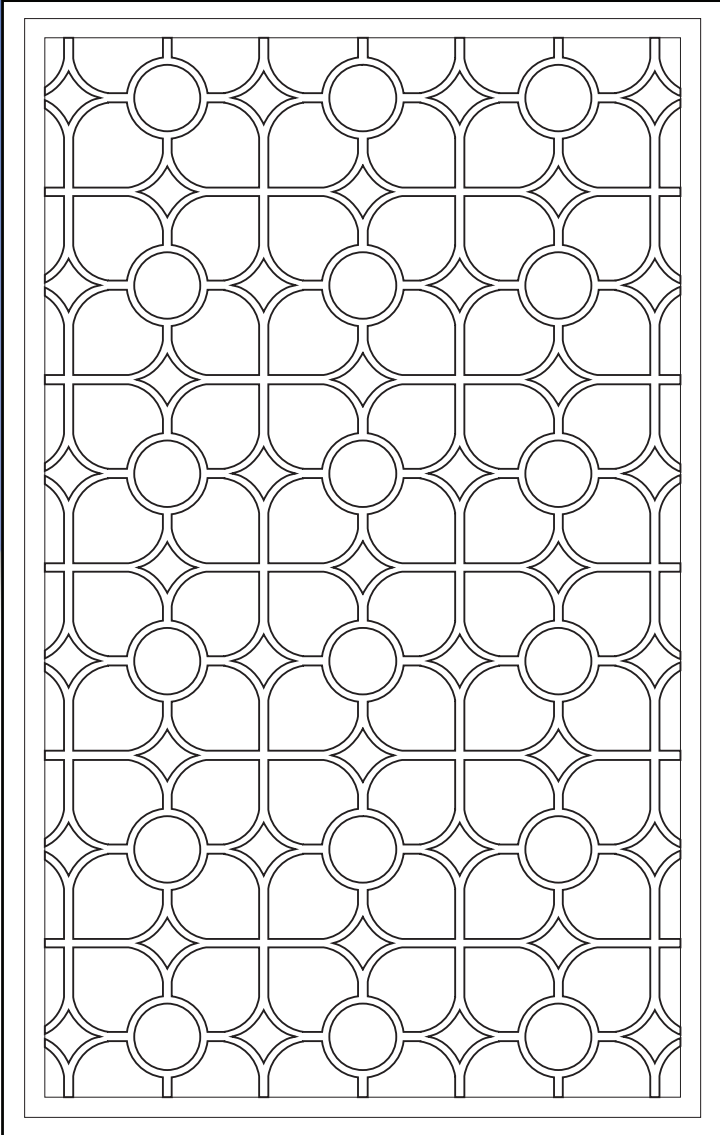

**FLEXIBLE CHAPLIN  
CEILING PATTERN**

- Flexible material for flat or curved ceilings.
- All modular ceilings can easily be modified to create many new designs. (Call for info. Multiple patterns available).
- Quicker & easier installation vs plaster ceilings.
- Does not require specialized installers.
- Material can be stained or painted.

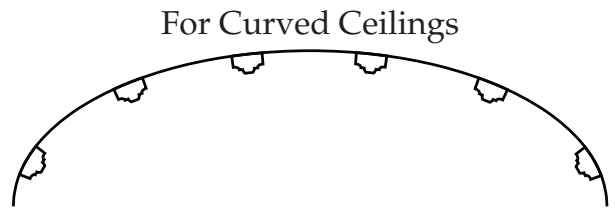

MLD-164

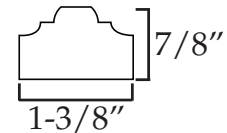

Moulding Profile of Chaplin Ceiling

CEIL-164B

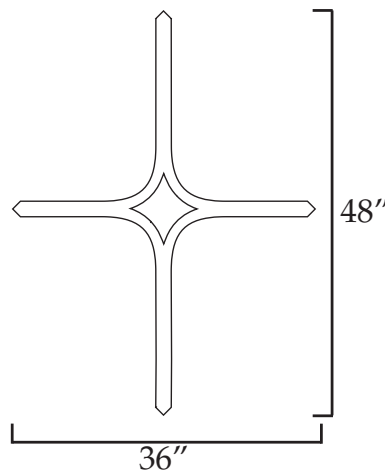

CEIL-164C

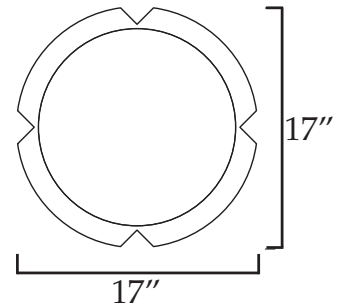

# CHAPLIN CEILING VARIATIONS

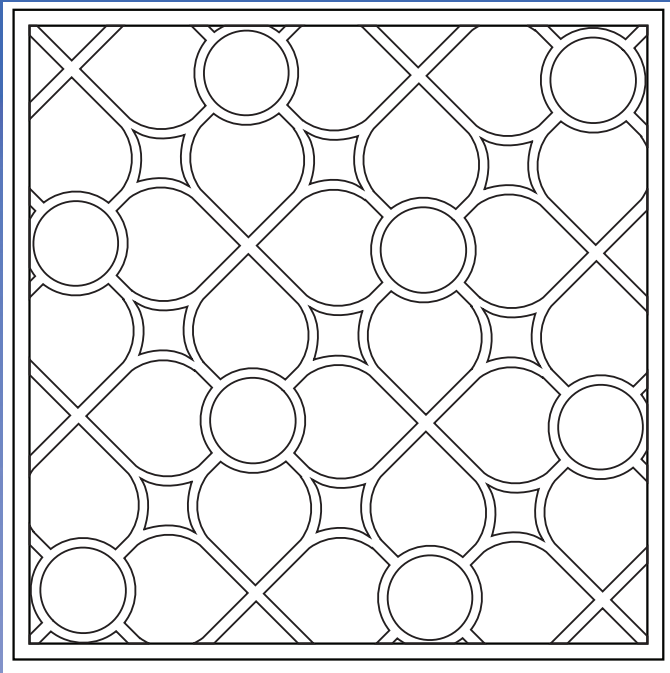

Series 3

Variation 2

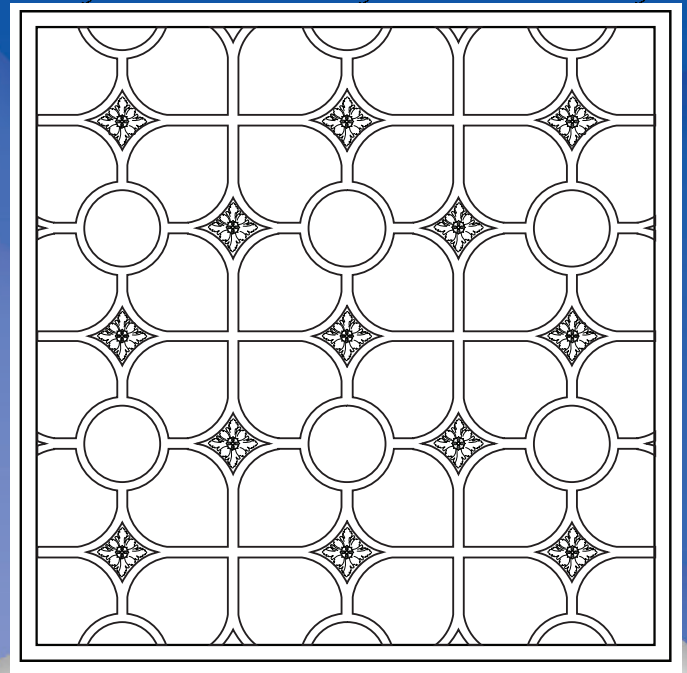

Series 3

Variation 3

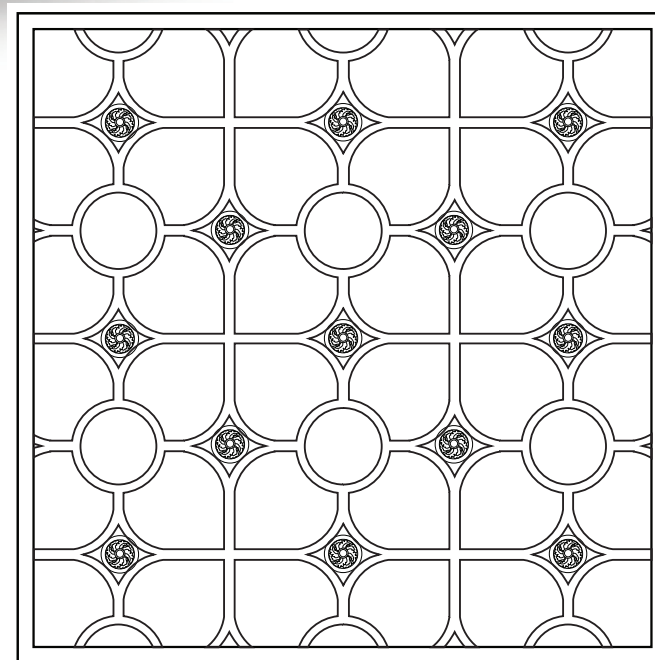

Series 3

Variation 4

**Call Pearlworks for Details!**

\*Final pricing depends on pattern density, pattern Layout, and waste factors.

# CHAPLIN CEILING

# SERIES 4

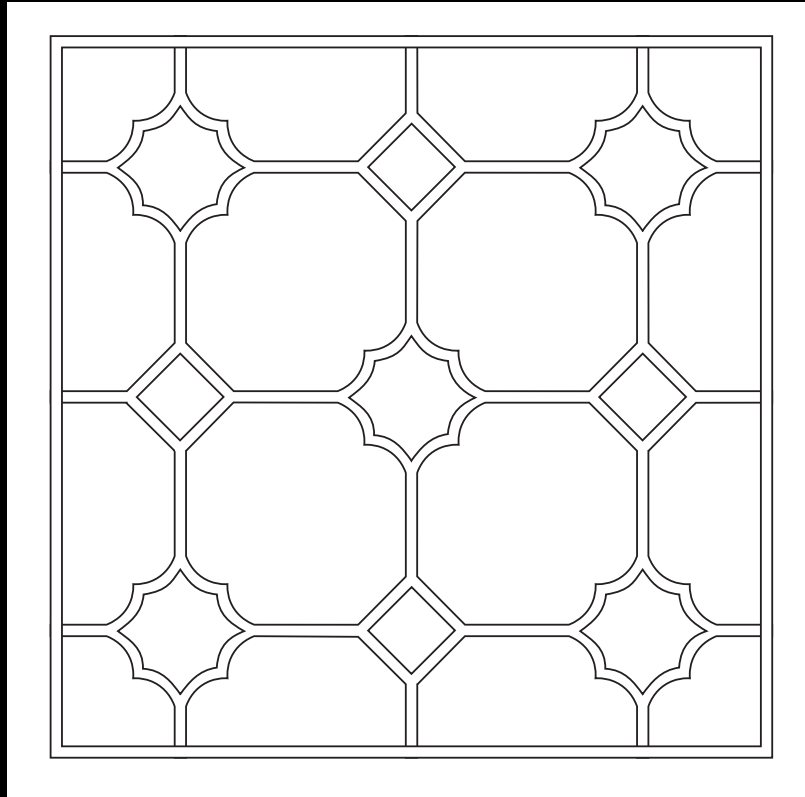

The PEARLWORKS CHAPLIN CEILING was designed using only two components that are both flexible and adjustable. This is the only ceiling on the market that offers these unique features.

**FLEXABILITY:** Let's talk about the flexibility of our product. Unlike plaster ceilings that are rigid and brittle, PEARLWORKS flexible ceiling components are both pliable and durable. Why is this important? Shorter and easier Installation times. Just Imagine being able to install this ceiling to curved surfaces at no additional cost or time! Something that is both difficult and expensive to do in plaster.

**INSTALLATION:** I have never seen a drywall or plaster ceiling that was perfectly flat! PEARLWORKS flexible ceilings components give a tighter fit for imperfect ceiling surfaces. Typically Flexible ceiling installations require 60 to 70 percent less time.

**MATERIAL COST:** Depending on who you are buying your plaster ceiling from, Pearlworks flexible ceilings are very competitively priced. Imagine..... Less material cost, less installation time, infinite design possibilities and most importantly we have all ceilings in stock.

**SHIPPING AND PACKAGING COST:** Because plaster is a more brittle product, breakage in shipping is more likely to occur. Packaging plaster products is also more expensive and time consuming.

**DESIGN OPTIONS:** Pearlworks offers multiple variations within each ceiling pattern. Additionally, optional carving details can be added to the ceiling offering hundreds of different looks. This flexibility allows our customers to custom match every detail to match exactly the look they want. Pearlworks is the only manufacturer in the world presently offering this feature.

**Series 4**

**Variation 1**

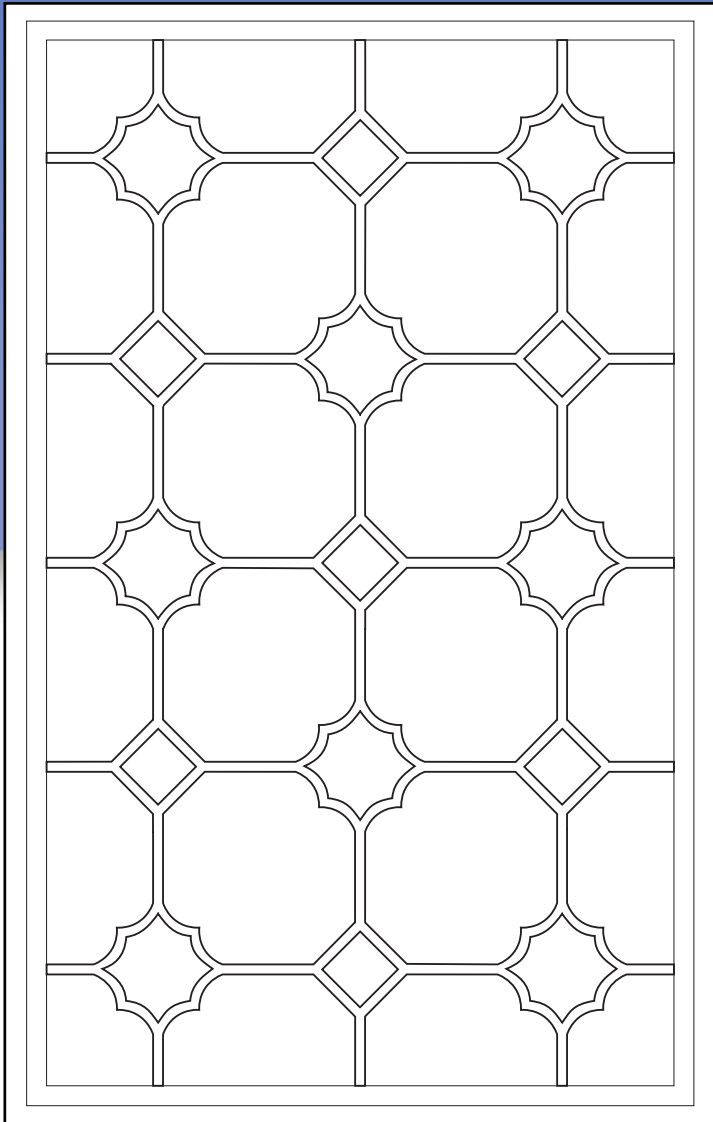

**FLEXIBLE CHAPLIN  
CEILING PATTERN**

- Flexible material for flat or curved ceilings.
- All modular ceilings can easily be modified to create many new designs. (Call for info. Multiple patterns available).
- Quicker & easier installation vs plaster ceilings.
- Does not require specialized installers.
- Material can be stained or painted.

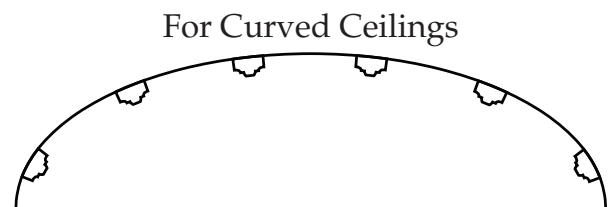

MLD-164

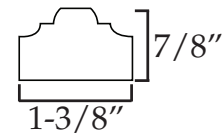

Moulding Profile of Chaplin Ceiling

CEIL-164B

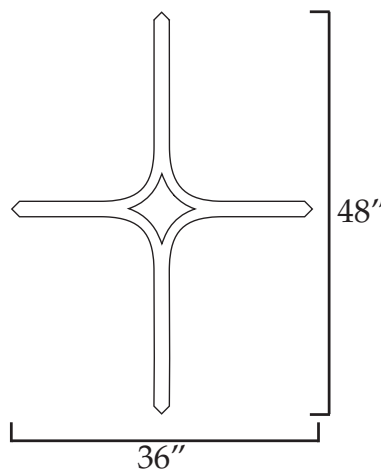

CEIL-164D

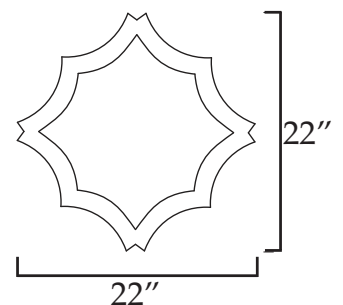

# CHAPLIN CEILING VARIATIONS

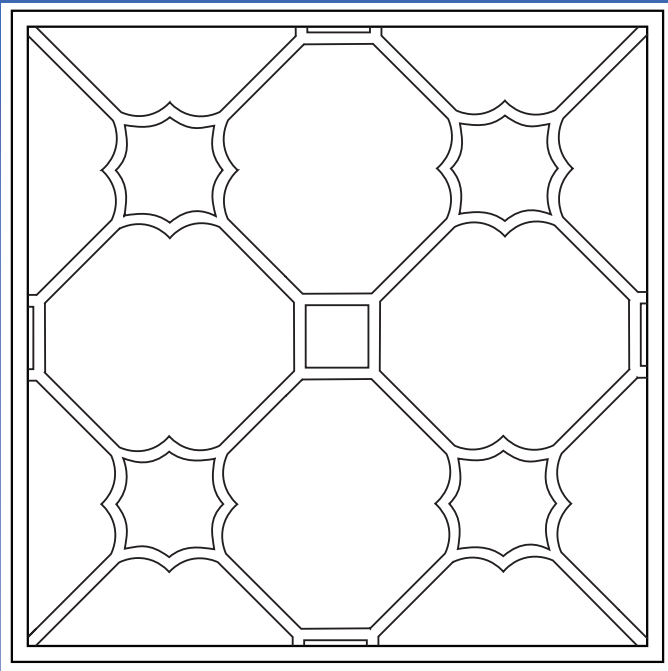

Series 4

Variation 2

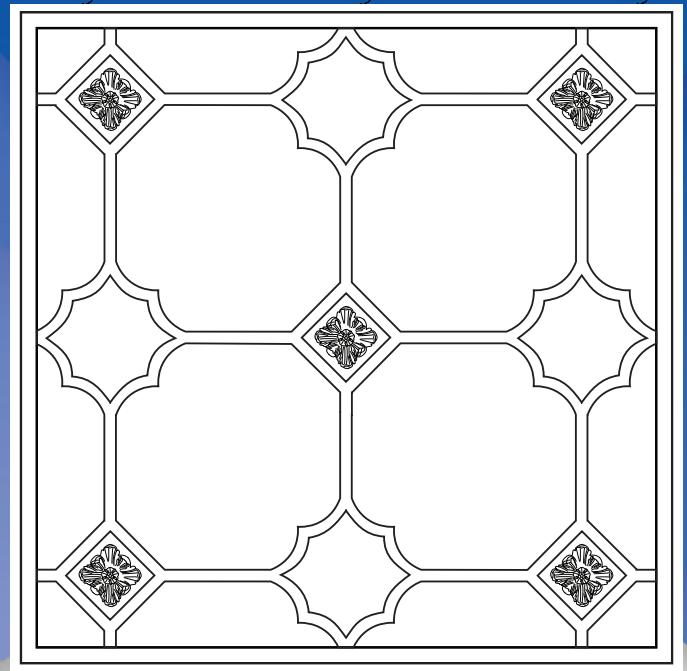

Series 4

Variation 4

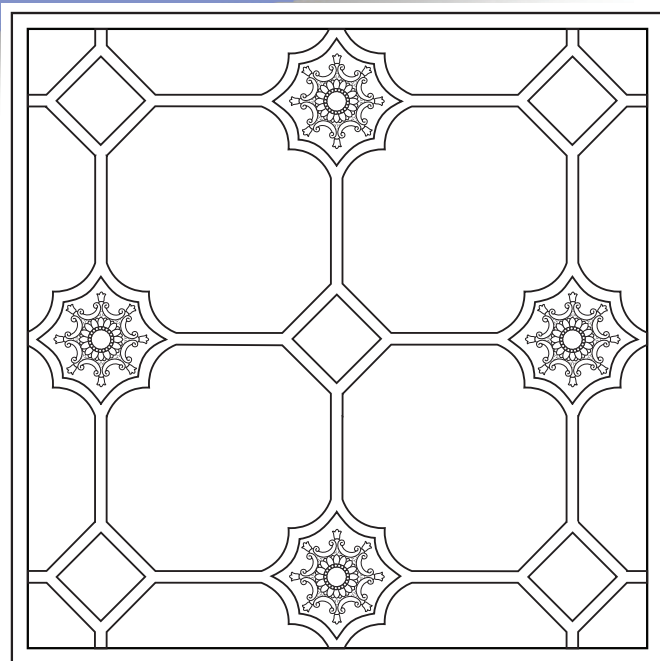

Series 4

Variation 5

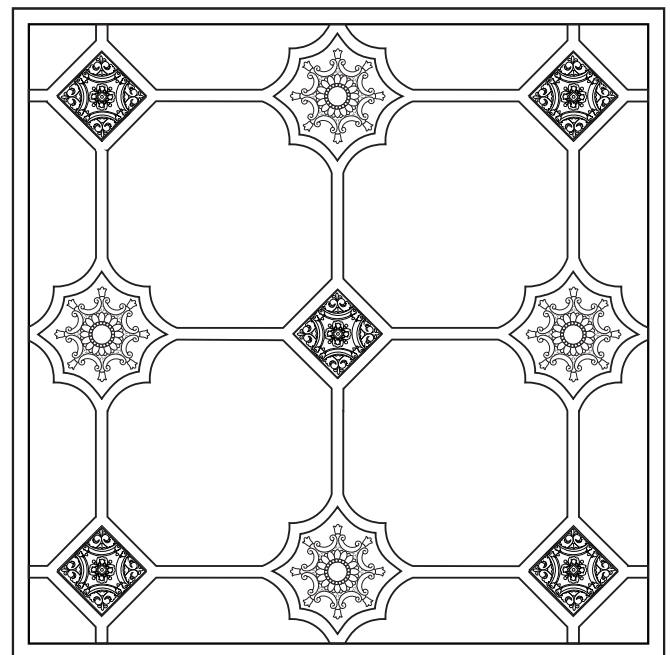

Series 4

Variation 6

Call Pearlworks for Details!



# GRAHAM CEILING



**FLEXIBILITY:** Let's talk about the flexibility of our product. Unlike plaster ceilings that are rigid and brittle, PEARLWORKS flexible ceiling components are both pliable and durable. Why is this important? Shorter and easier Installation times. Just Imagine being able to install this ceiling to curved surfaces at no additional cost or time! Something that is both difficult and expensive to do in plaster.

**INSTALLATION:** I have never seen a drywall or plaster ceiling that was perfectly flat! PEARLWORKS flexible ceilings components give a tighter fit for imperfect ceiling surfaces. Typically flexible resin ceiling installations require 60 to 70 percent less time.

**MATERIAL COST:** Depending on who you are buying your plaster ceiling from, Pearlworks flexible ceilings are very competitively priced. Imagine..... Less material cost, less installation time, infinite design possibilities and most importantly we have all ceilings in stock.

**SHIPPING AND PACKAGING COST:** Because plaster is a more brittle product, breakage in shipping is more likely to occur. Packaging plaster products is also more expensive and time consuming.

**DESIGN OPTIONS:** Pearlworks offers multiple variations within each ceiling pattern. Additionally, optional carving details can be added to the ceiling offering hundreds of different looks. This flexibility allows our customers to custom match every detail to match exactly the look they want. Pearlworks is the only manufacturer in the world presently offering this feature.

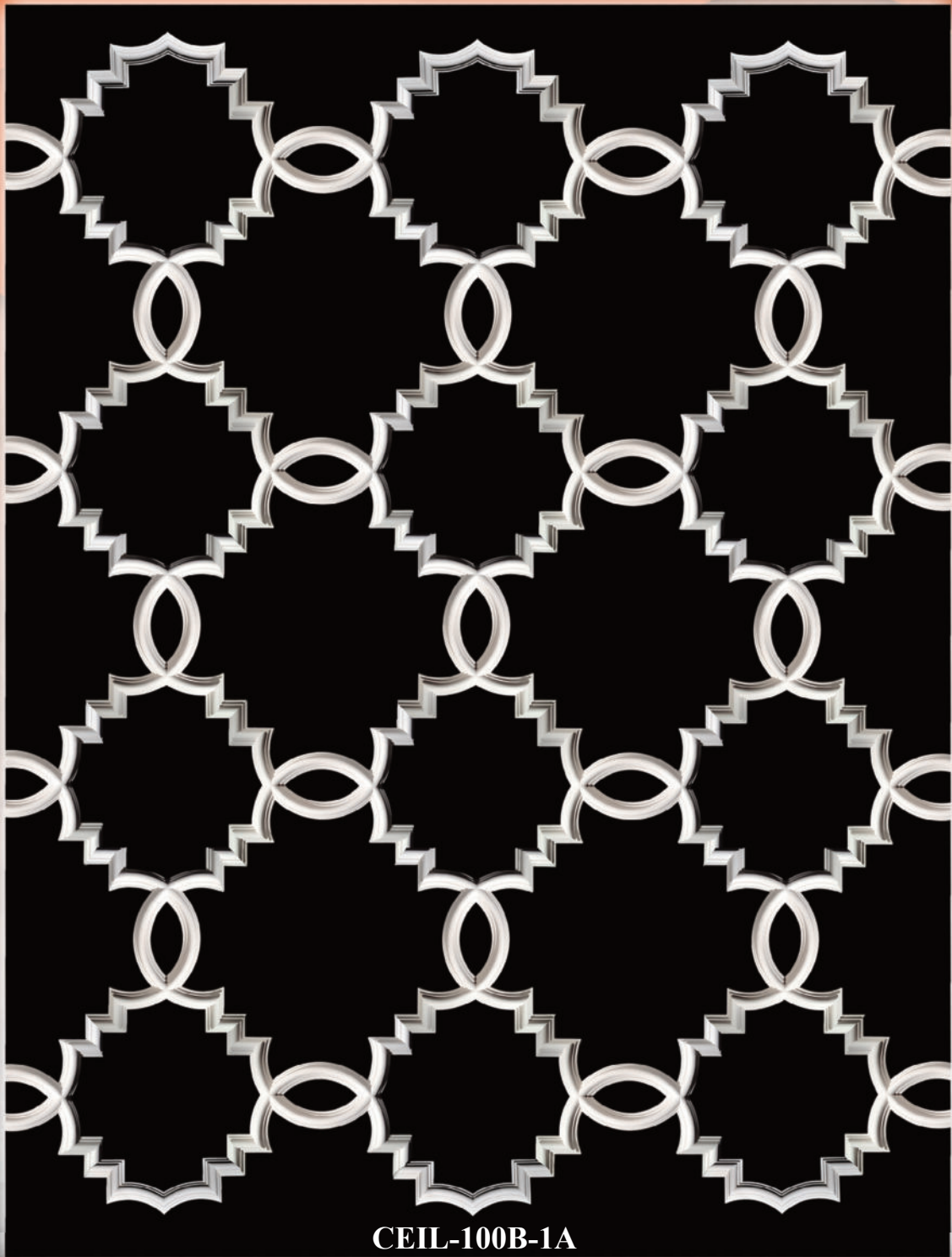
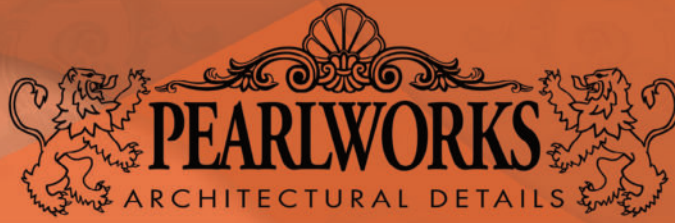

CEIL-100B-1A

*Introducing the very large array of*  
**THE GRAHAM CEILING**

# GRAHAM CEILING CONCEPT

## CEIL-100B-1A *(Triple OG shown)*

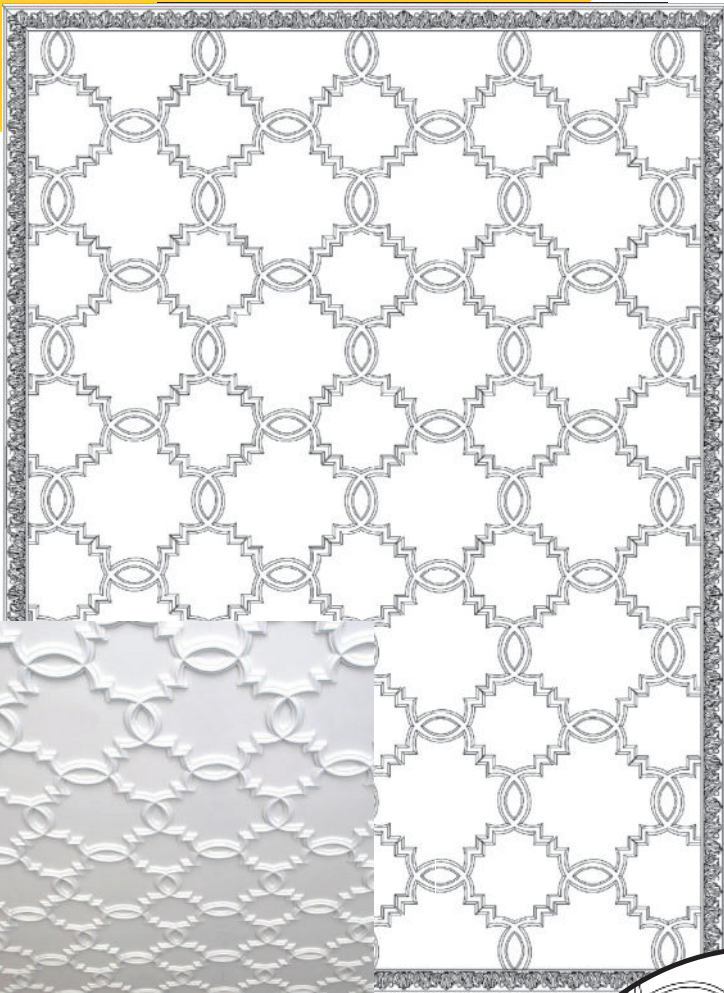

### FLEXIBLE GRAHAM CEILING PATTERN

- This classic geometric ceiling complements any room.
- All modular ceilings can easily be modified to create many new designs. (Call for info. Multiple patterns and layouts available.)
- Flexible material for flat or curved ceilings.
- Quicker & easier installation vs plaster ceilings. "NO" seams to blend.

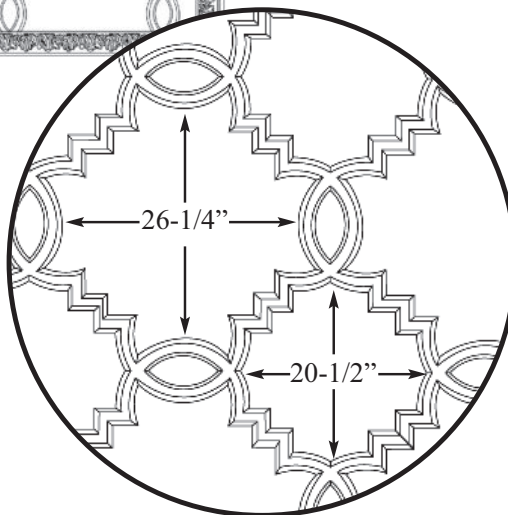

CEIL-100-3EXT

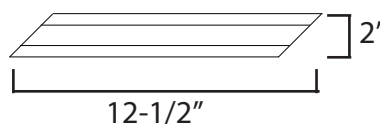

For Flat Ceilings

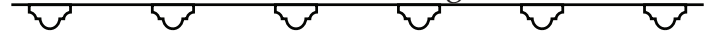

For Curved Ceilings

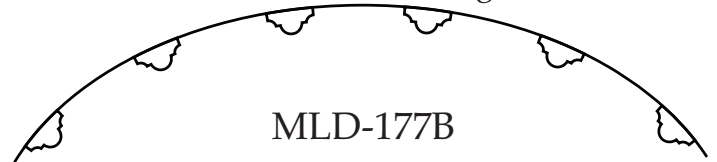

MLD-177B

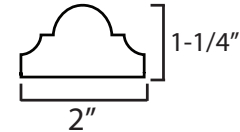

Moulding Profile of Graham Ceiling

This classic ceiling from the castles of Europe can now be duplicated using Pearlworks Flexible Modular System. All modular ceilings can be easily laid out to create multiple designs using the same components.

CEIL-100B

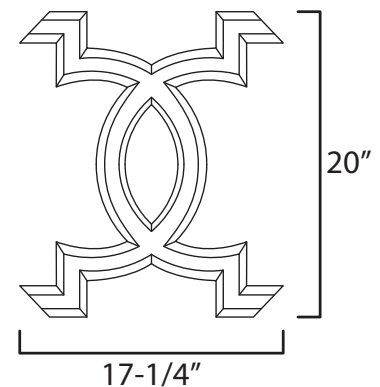

CEIL-100B-EXT

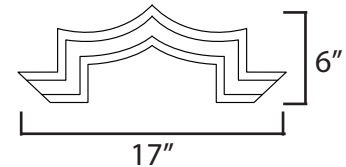

CEIL-100-2EXT

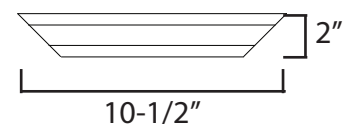

# GRAHAM CEILING CONCEPT

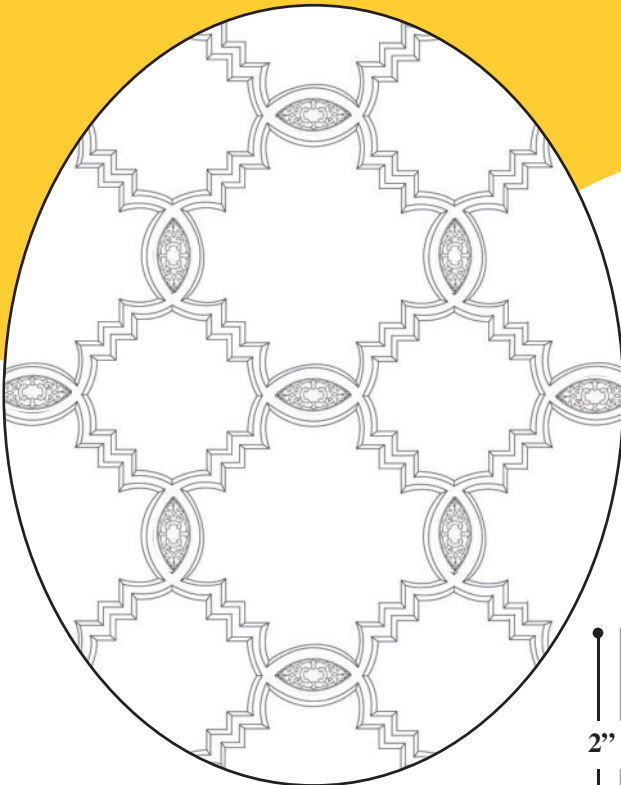

**CEIL-100B-1B**

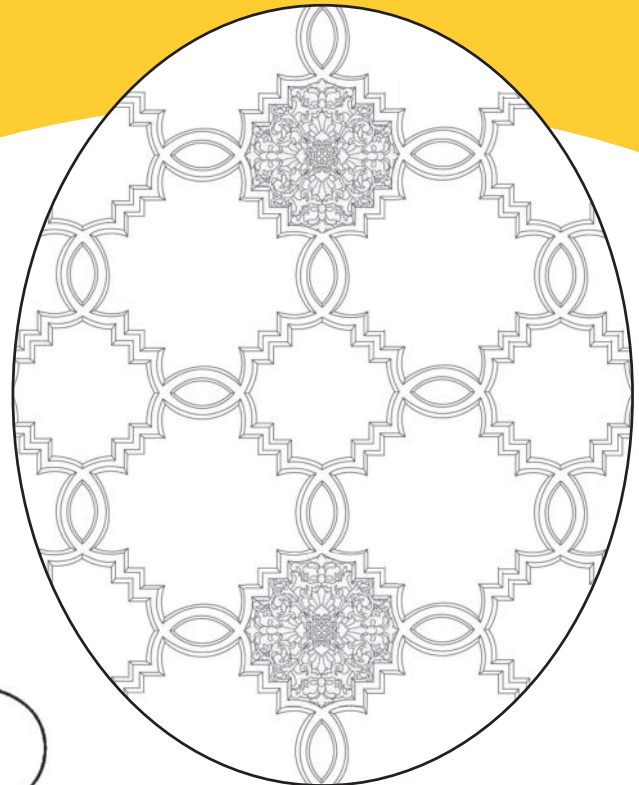

**CEIL-100B-1C**

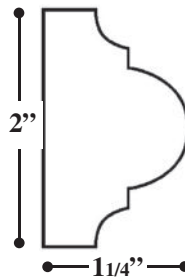

**Moulding Profile**  
Ceiling Pattern, goes with  
Moulding Straights.  
MLD-177B

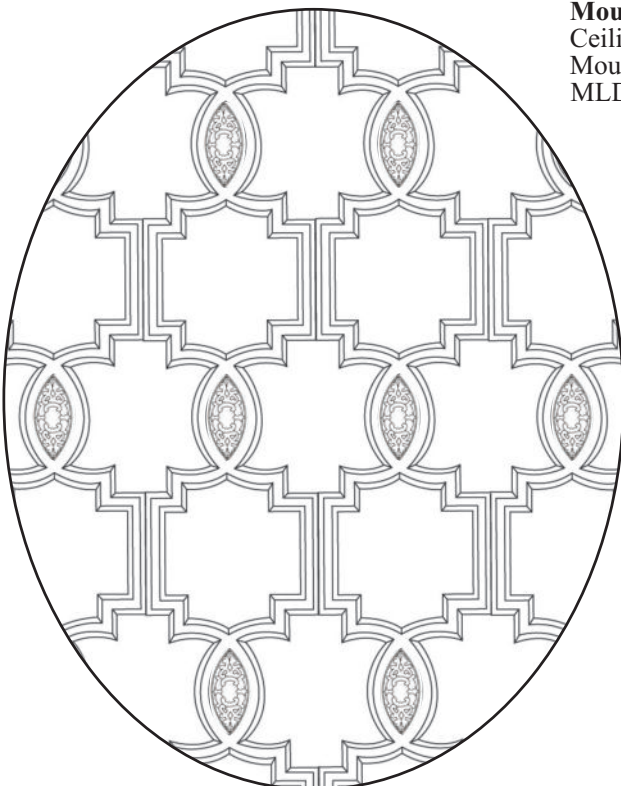

**CEIL-100B-3A**

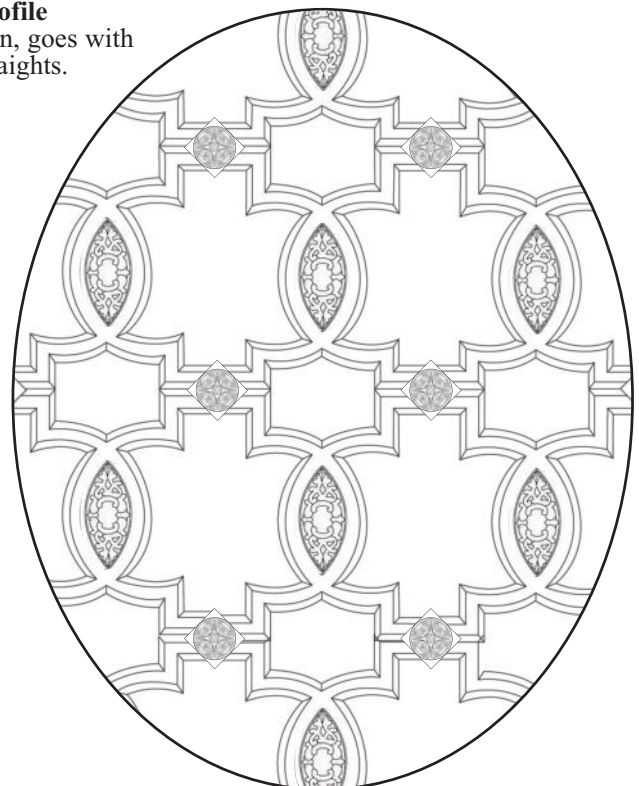

**CEIL-100B-5A**

*\*See Website for More Options\**

# MONACO CORNER CEILING PANEL

**PANL-301**

60" x 60" x 1-1/4"

Sold as a 6 piece set.

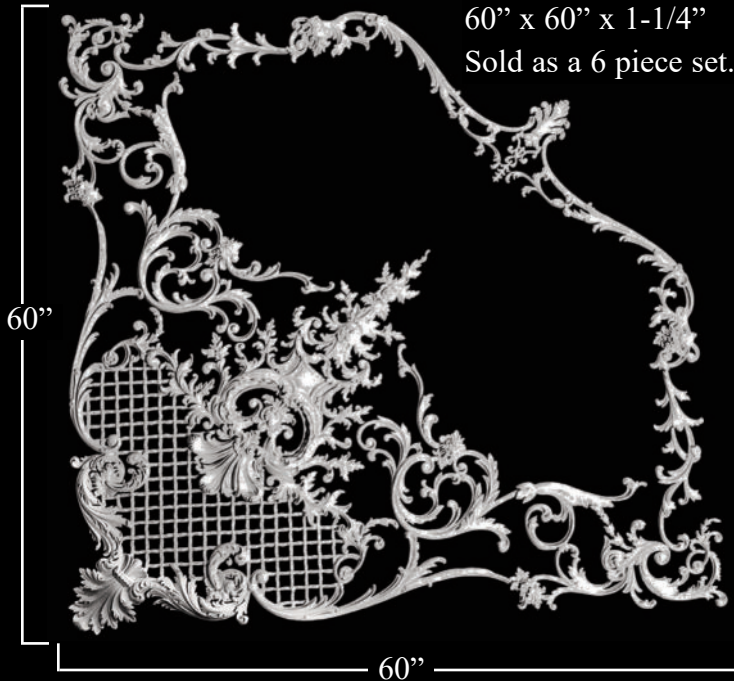

## Monaco Ceiling Advantages:

- Panels in stock ready to ship!
- Modular Design allows for infinite Custom Design capabilities.
- Lightweight and flexible for easy installation.
- Most ceiling designs can be installed in one day. A huge savings vs. plaster installations that take weeks to complete.
- Our designs are flexible at no additional cost which allows for easy installation on all radius and flat ceiling surfaces.....barrel ceilings our specialty!
- All Pearlworks parts are stainable and paintable.
- All masters are hand carved for unmatched detail. We never use a CNC machine!
- Installation can be done by carpenters using standard wood working tools. This eliminates the high cost of specialty installation crews.



Close up of detail.

## MONACO CEILING CONCEPT

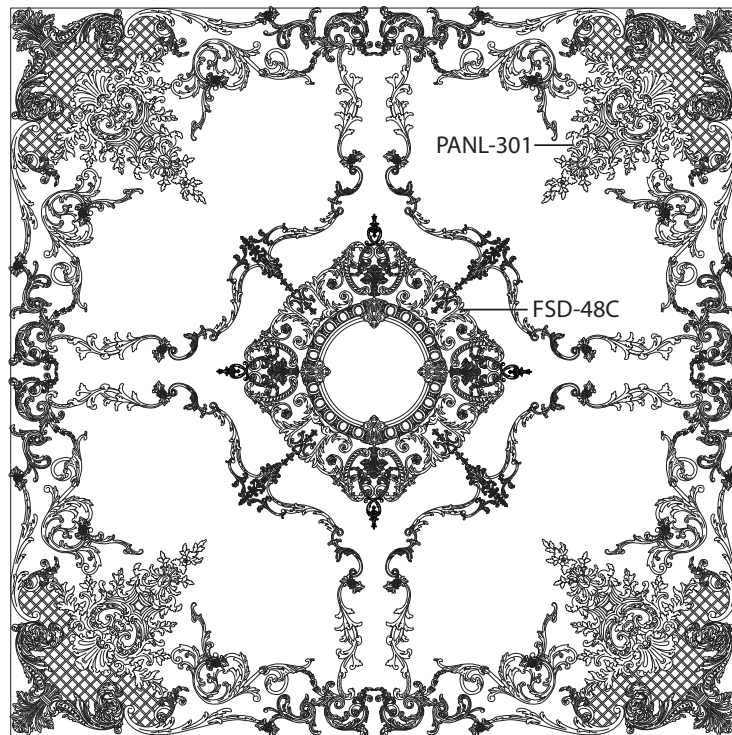

120" (10')

120"  
(10')

CEILINGS

# MONACO CORNER CEILING PANEL

## MONACO CEILING CONCEPT

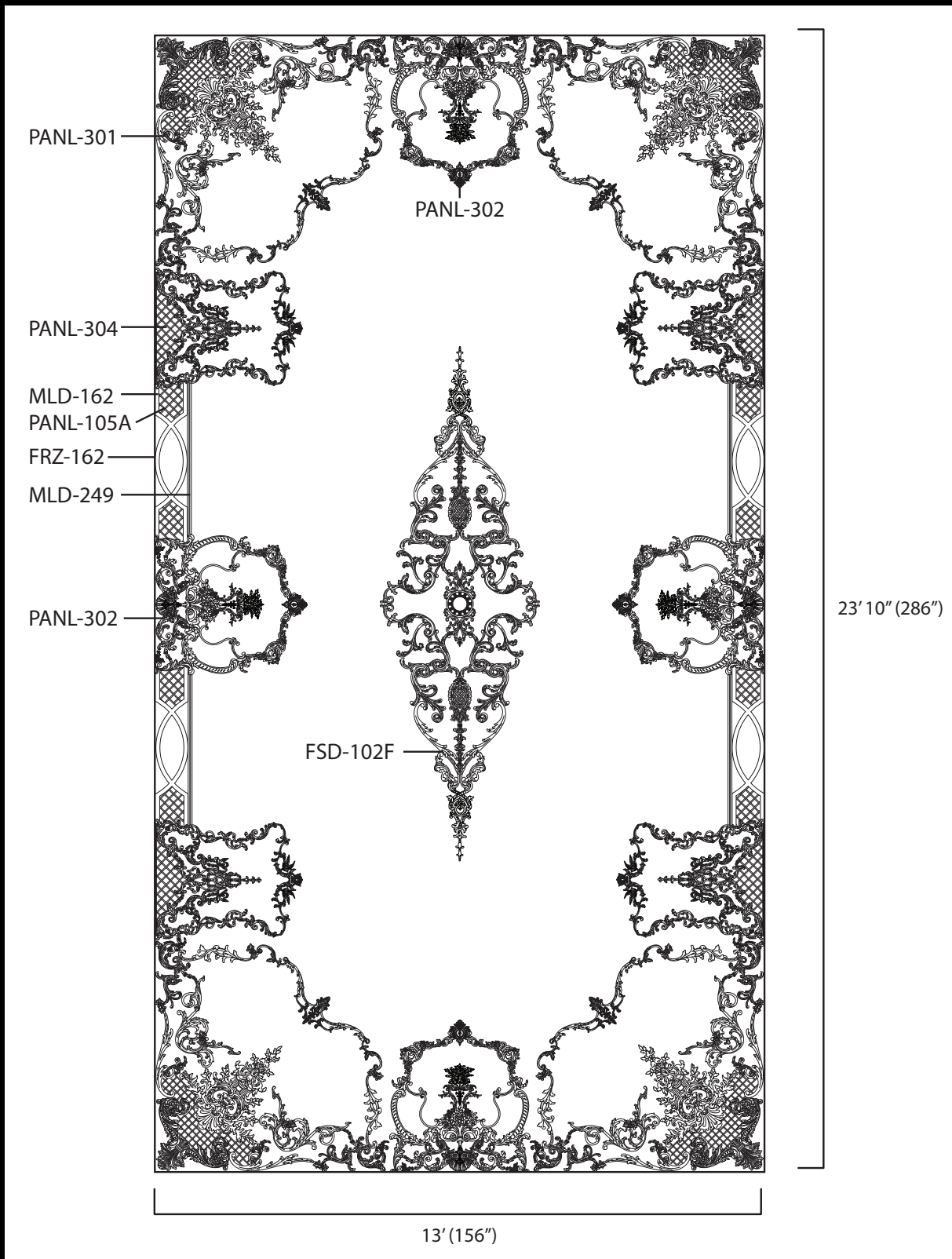

# MONACO CEILING PANEL

**PANL-302**

36" x 39" x 1-1/2"

Sold as a 5 piece set.



Close up of detail.

## Monaco Ceiling Advantages:

- Panels in stock ready to ship!
- Modular Design allows for infinite Custom Design capabilities.
- Lightweight and flexible for easy installation.
- Most ceiling designs can be installed in one day. A huge savings vs. plaster installations that take weeks to complete.
- Our designs are flexible at no additional cost which allows for easy installation on all radius and flat ceiling surfaces.....barrel ceilings our specialty!
- All Pearlworks parts are stainable and paintable.
- All masters are hand carved for unmatched detail. We never use a CNC machine!
- Installation can be done by carpenters using standard wood working tools. This eliminates the high cost of specialty installation crews.

## MONACO CEILING CONCEPT

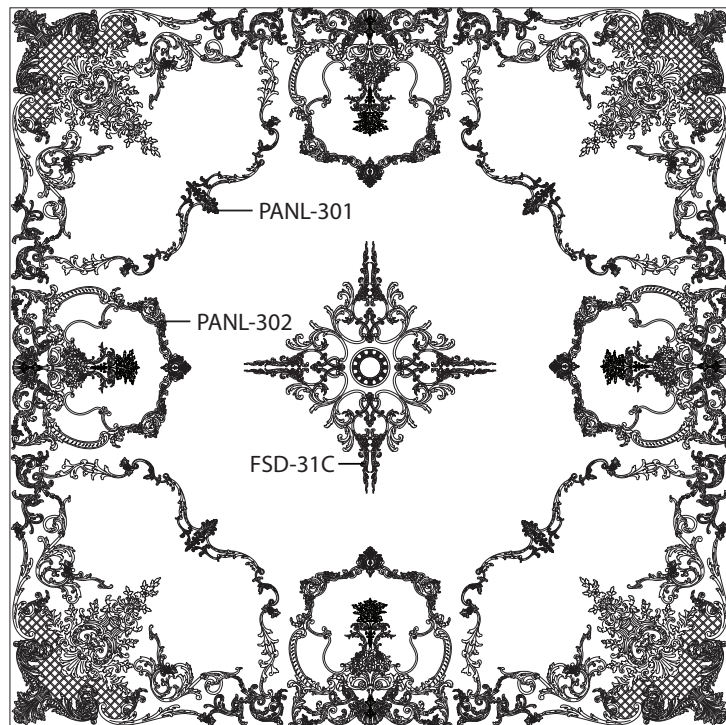

156"  
(13')

156" (13')

CEILINGS

# MONACO CORNER CEILING PANEL

## MONACO CEILING CONCEPT

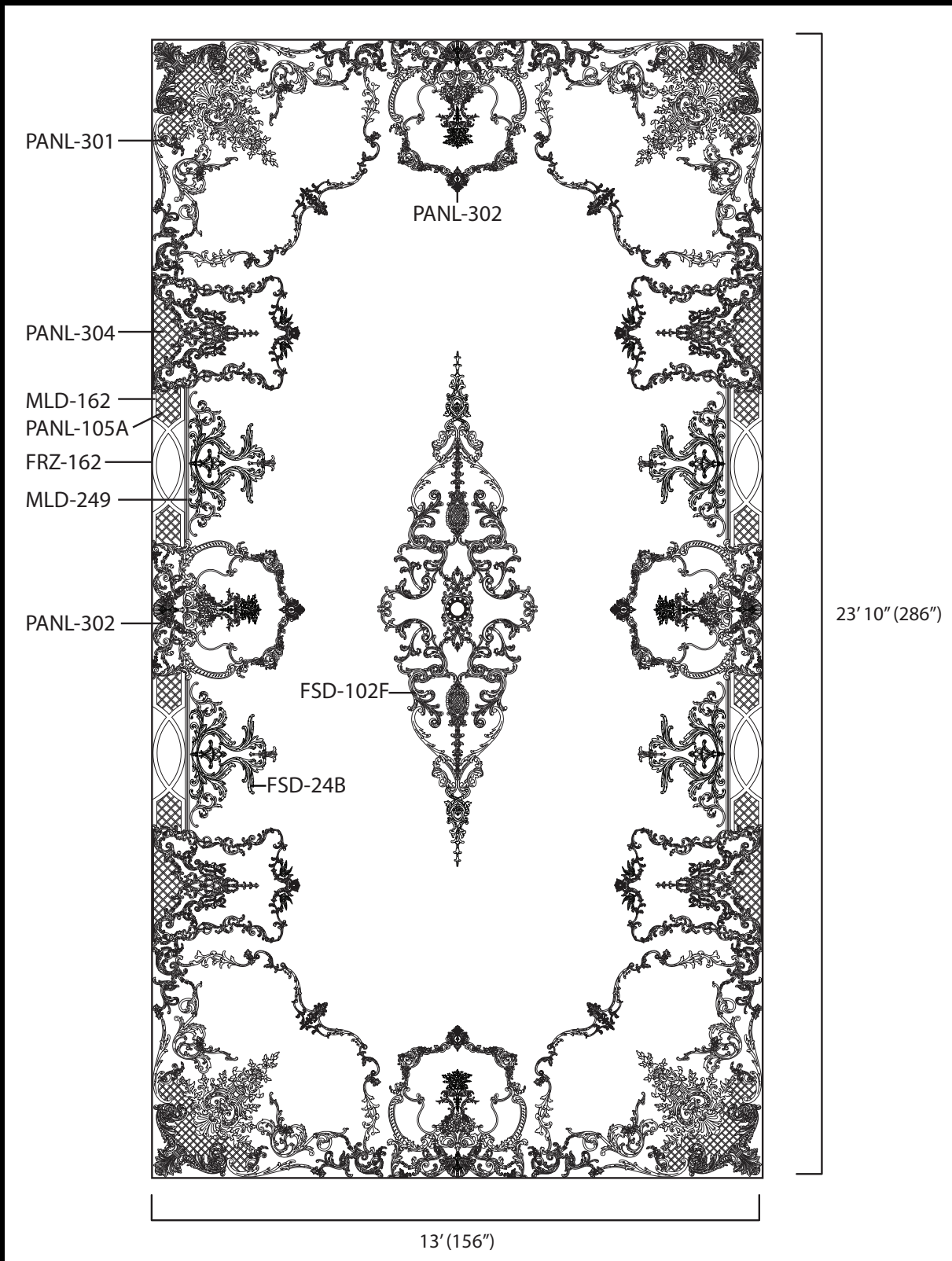



# MONACO CEILING PANEL

## PANL-303

36" x 39" x 1-1/4"

Sold as a 5 piece set.



## Monaco Ceiling Advantages:

- Panels in stock ready to ship!
- Modular Design allows for infinite Custom Design capabilities.
- Lightweight and flexible for easy installation.
- Most ceiling designs can be installed in one day. A huge savings vs. plaster installations that take weeks to complete.
- Our designs are flexible at no additional cost which allows for easy installation on all radius and flat ceiling surfaces.....barrel ceilings our specialty!
- All Pearlworks parts are stainable and paintable.
- All masters are hand carved for unmatched detail. We never use a CNC machine!
- Installation can be done by carpenters using standard wood working tools. This eliminates the high cost of specialty installation crews.

## MONACO CEILING CONCEPT

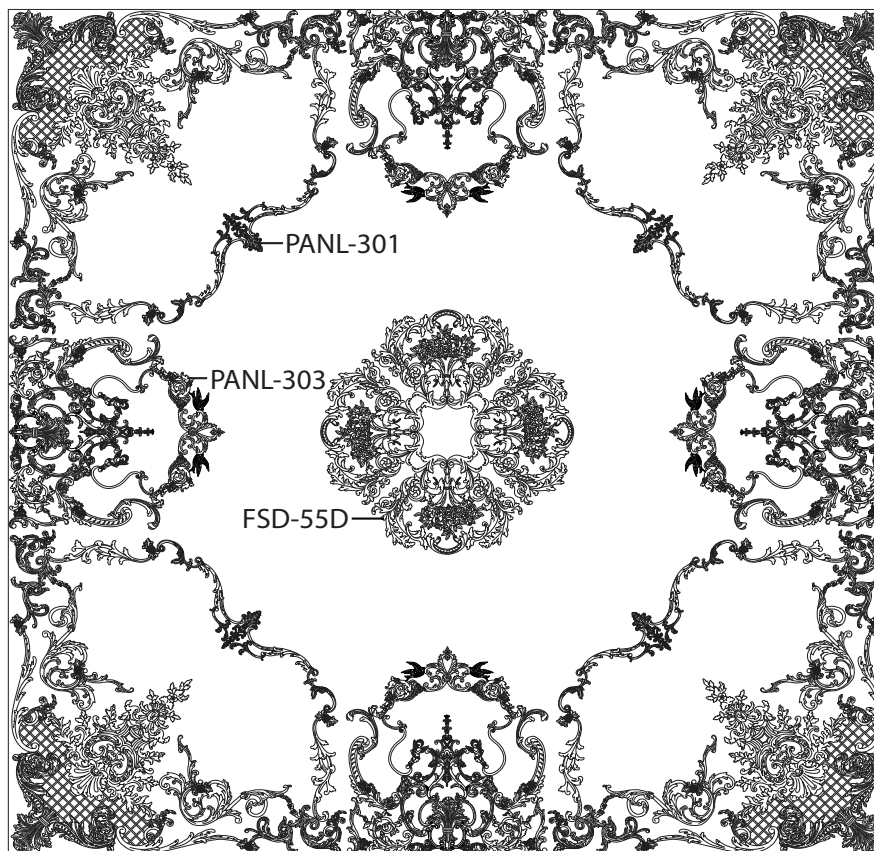

156"  
(13')

156" (13')

CEILING

# MONACO CORNER CEILING PANEL

## MONACO CEILING CONCEPT

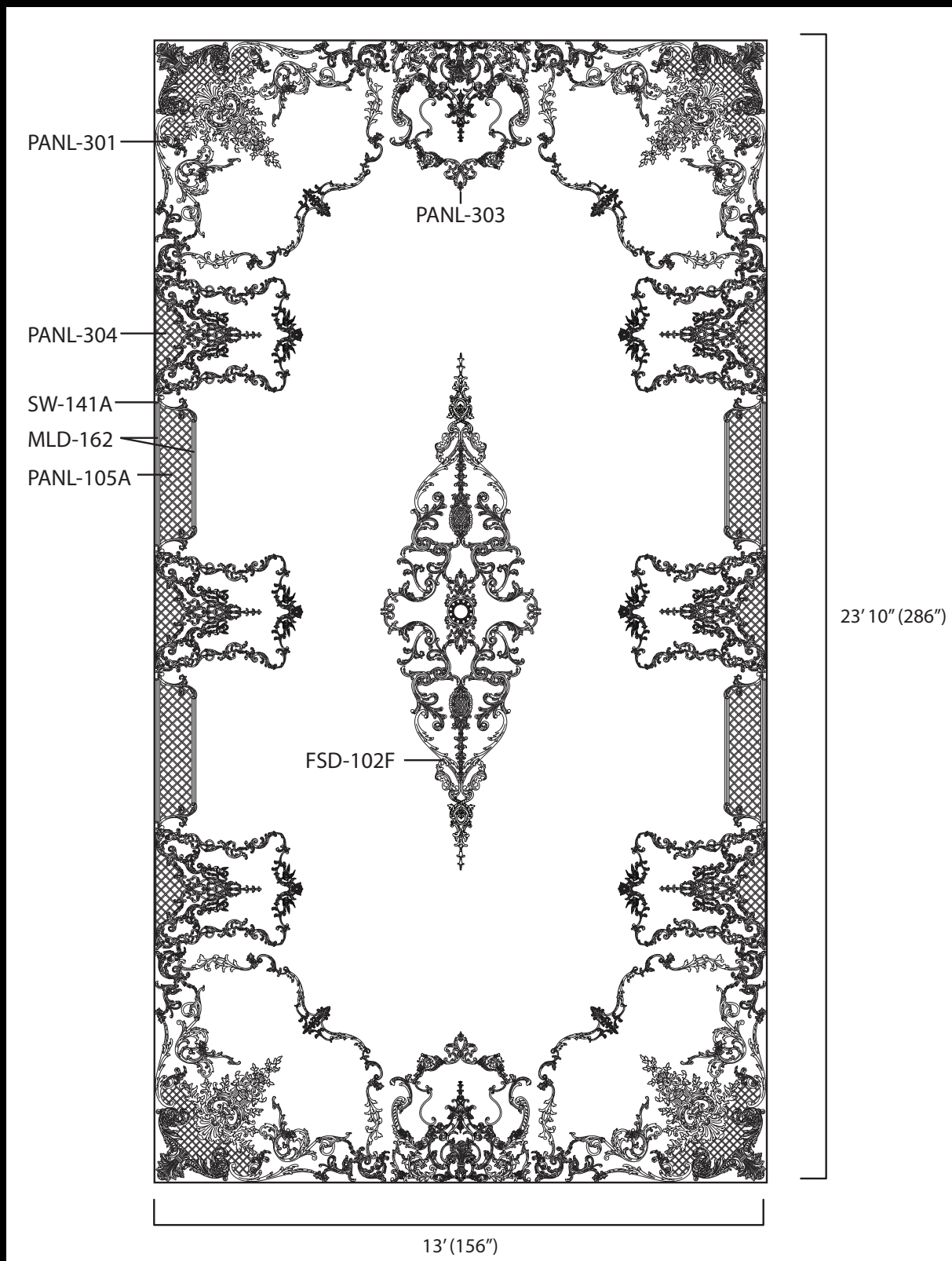

# MONACO CEILING PANEL

**PANL-304**  
32" x 40" x 3/4"

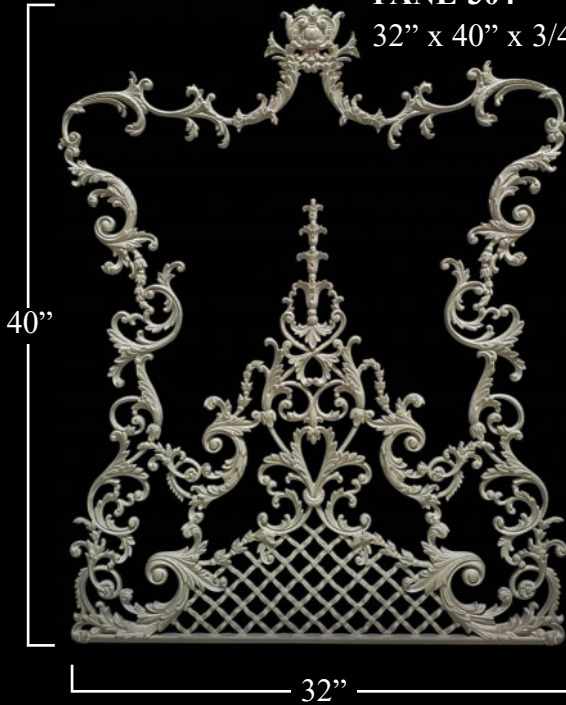

## Monaco Ceiling Advantages:

- Panels in stock ready to ship!
- Modular Design allows for infinite Custom Design capabilities.
- Lightweight and flexible for easy installation.
- Most ceiling designs can be installed in one day. A huge savings vs. plaster installations that take weeks to complete.
- Our designs are flexible at no additional cost which allows for easy installation on all radius and flat ceiling surfaces.....barrel ceilings our specialty!
- All Pearlworks parts are stainable and paintable.
- All masters are hand carved for unmatched detail. We never use a CNC machine!
- Installation can be done by carpenters using standard wood working tools. This eliminates the high cost of specialty installation crews.

## MONACO CEILING CONCEPT

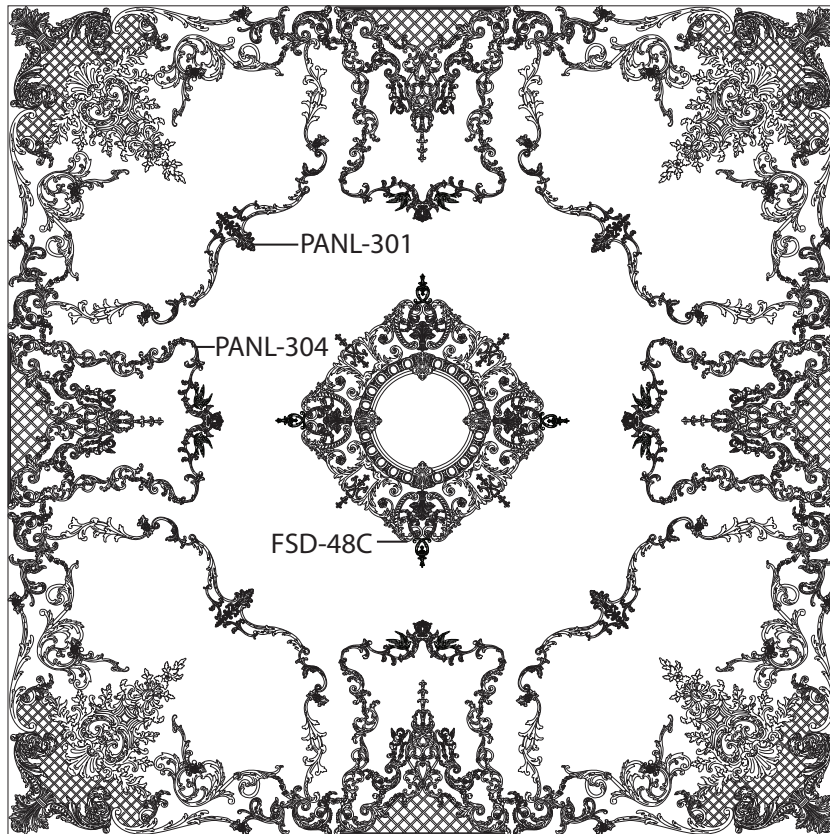

152"  
(12' 8")

152" (12' 8")

CEILINGS

# MONACO CORNER CEILING PANEL

## MONACO CEILING CONCEPT

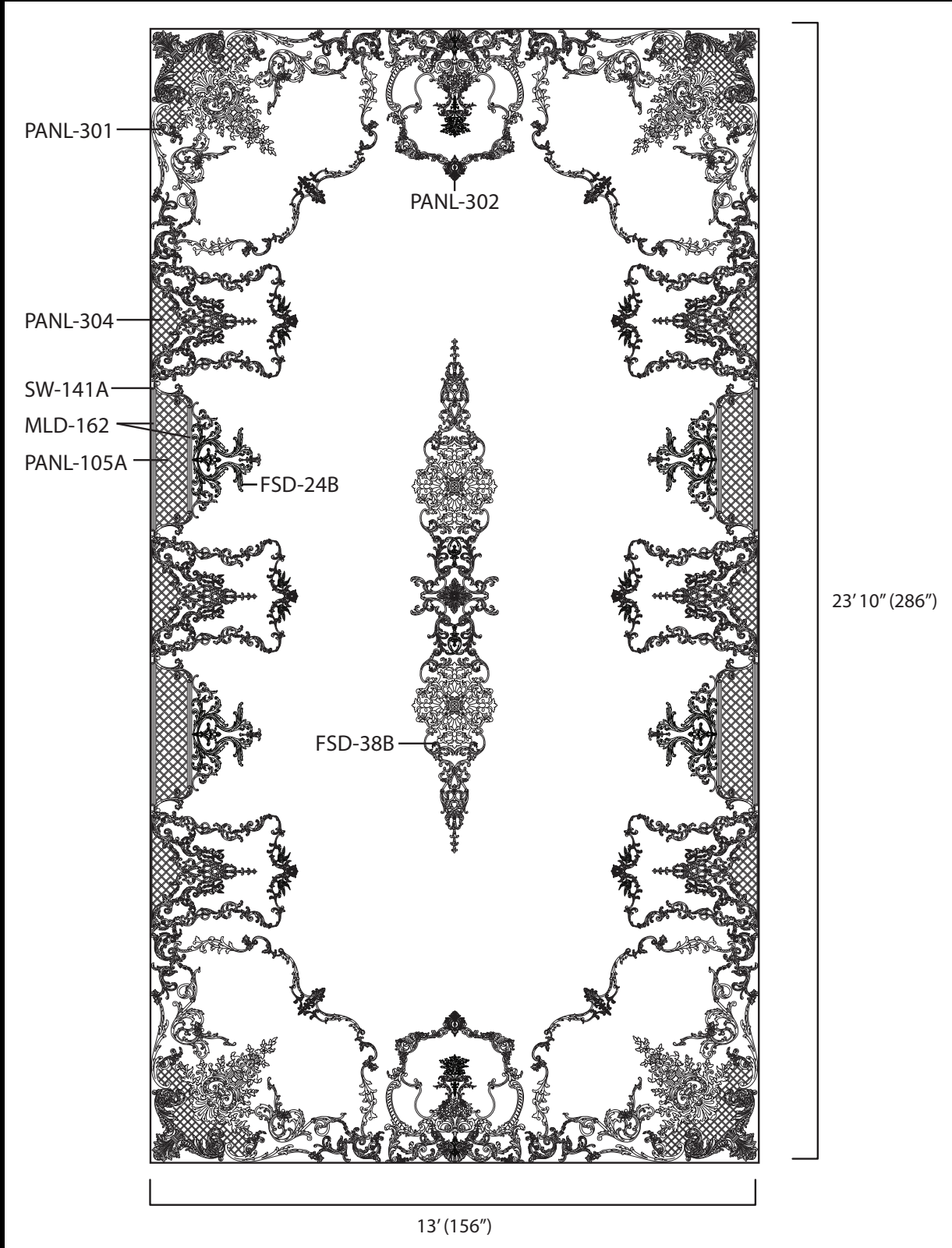

# MONACO CEILING PANEL

## Monaco Ceiling Advantages:

- Modular Design allows for infinite Custom Design capabilities.
- Lightweight and flexible for easy installation.
- Most ceiling designs can be installed in one day. A huge savings vs. plaster installations that take weeks to complete.
- Our designs are flexible at no additional cost which allows for easy installation on all radius and flat ceiling surfaces.....barrel ceilings our specialty!
- All Pearlworks parts are stainable and paintable.
- All masters are hand carved for unmatched detail. We never use a CNC machine!
- Installation can be done by carpenters using standard wood working tools. This eliminates the high cost of specialty installation crews.
- Panels in stock ready to ship!

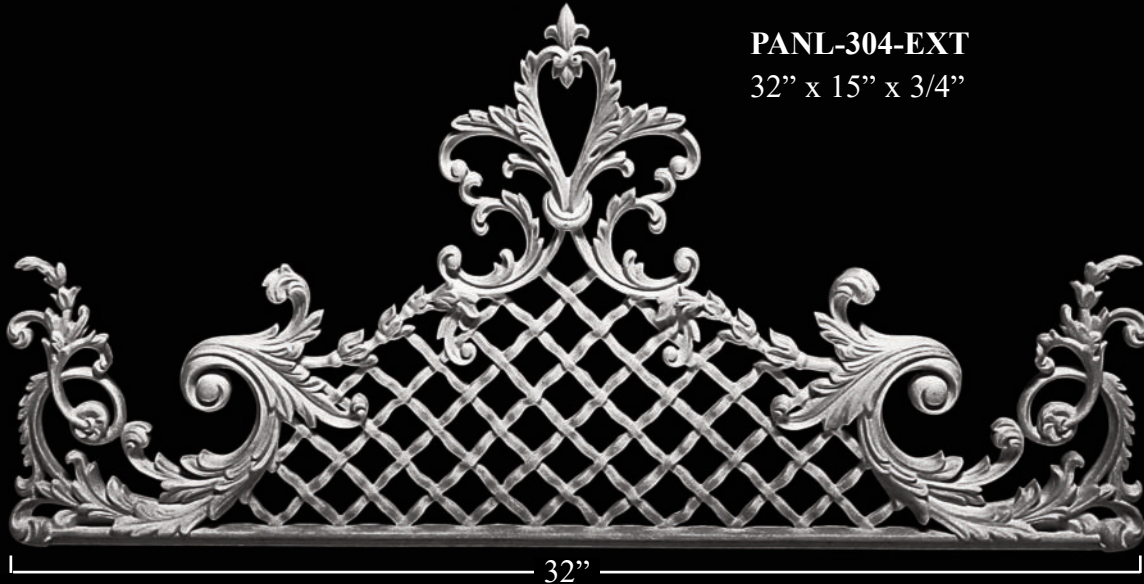

**PANL-304-EXT**  
32" x 15" x 3/4"

### MONACO CEILING CONCEPT

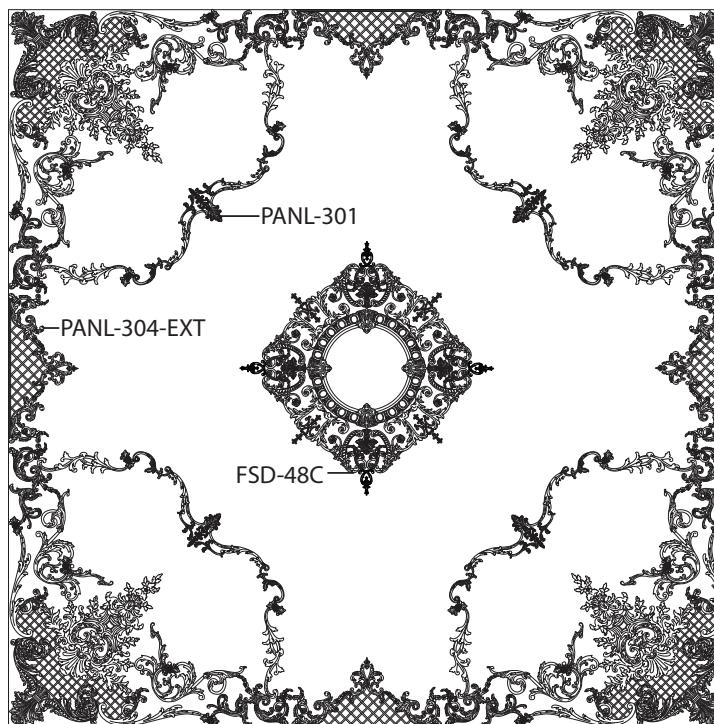

152" (12' 8")

152"  
(12' 8")

CEILINGS

\* All sizes are approx.- W" x H" x Thickness"

# MONACO CORNER CEILING PANEL

## MONACO CEILING CONCEPT

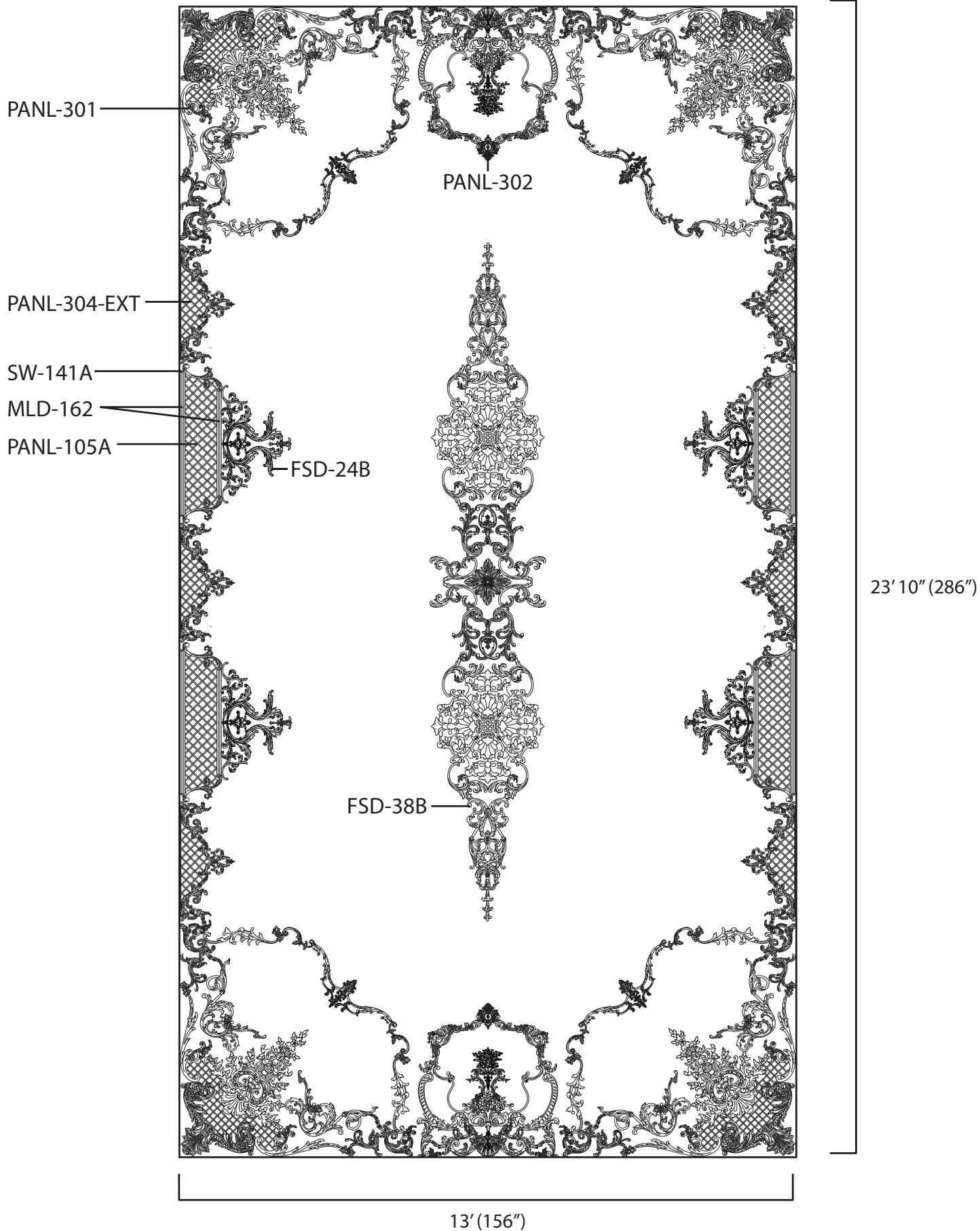

# CEILING PRICE LIST

#	Part Number	Price
1	CEIL-100B	\$119.95
2	CEIL-100B-EXT	\$38.95
3	CEIL-100-2EXT	\$14.95
4	CEIL-100-3EXT	\$15.95
5	CEIL-118	\$239.95
6	CEIL-119	\$419.95
7	CEIL-120	\$189.95
8	CEIL-122	\$189.95
9	CEIL-123A	\$189.95
10	CEIL-123B	\$189.95
11	CEIL-123C	\$189.95
12	CEIL-164A	\$59.95
13	CEIL-164B	\$169.95
14	CEIL-164C	\$59.95
15	CEIL-164D	\$69.95
16	CEIL-164E	\$59.95
17	CEIL-401	\$159.95
18	CEIL-402	\$189.95

# CEILINGS

