

# FRIEZES

All Resin Ornamentation is Flexible, Stainable & Paintable.



FRIEZES

Pearlworks, Inc. 14251 Franklin Ave. Tustin, CA 92780  
Office: (714) 573-1700 Fax: (714) 573-1708 Toll Free: (855) PEARLWORKS  
[www.pearlworksinc.com](http://www.pearlworksinc.com)

# FRIEZES

Linkable ends for unlimited lengths.

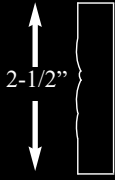

FRZ-100  
2-1/2" x 1/4" x 8'

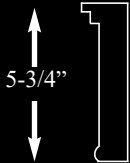

FRZ-101  
5-3/4" x 1-1/4" x 10'

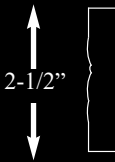

FRZ-103  
2-1/2" x 1/2" x 8'



FRZ-104  
5-1/4" x 3/4" x 8'



FRZ-105  
4" x 1" x 11'

# FRIEZES

Linkable ends for unlimited lengths.

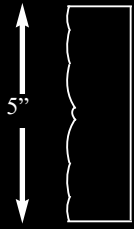

FRZ-106

5" x 1-1/4" x 5'



\* All sizes are approx.- max W" x max Thickness" x max length"

# FRIEZES

Linkable ends for unlimited lengths.

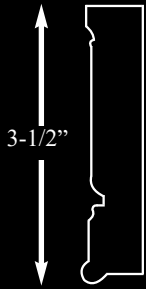

FRZ-107  
3-1/2" x 3/4" x 6'

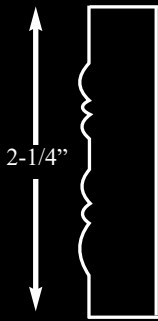

FRZ-110  
2-1/4" x 3/4" x 8'

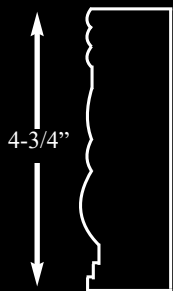

FRZ-111  
4-3/4" x 1" x 69-1/2"

# FRIEZES

Linkable ends for unlimited lengths.

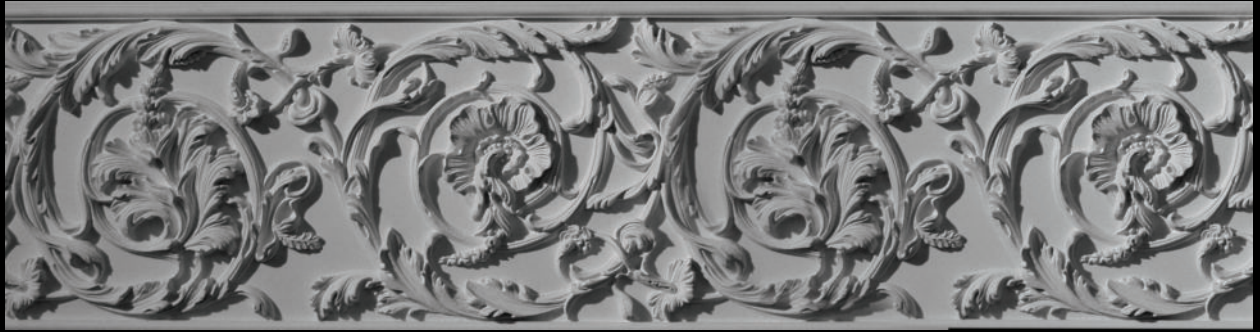
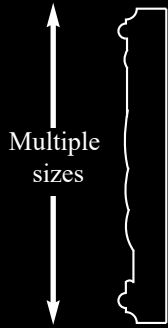

FRZ-115A  
8" x 1" x 6'

FRZ-115B  
11-1/2" x 1-1/4" x 66"

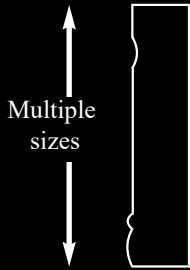

FRZ-117A  
3" x 1/2" x 10'

FRZ-117B  
5" x 1/2" x 10'

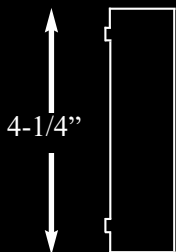

FRZ-118  
4-1/4" x 3/4" x 10'

FRIEZES

# FRIEZES

Linkable ends for unlimited lengths.

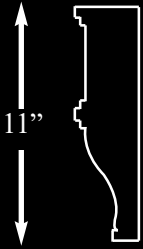

This FRIEZE was designed with Male and Female Ends. This allows linking for infinite lengths.

FRZ-120B

11" x 3-1/2" x 5'

Flex Resin Frieze

Designed for radius applications.

FRZ-F-120B

Sold as a 2 piece set.

11" x 3-1/2" x 5'

Polyurethane Foam Frieze

Designed for straight applications.



# FRIEZES

Linkable ends for unlimited lengths.



FRIEZES

\* All sizes are approx.- max W” x max Thickness” x max length”

# FRIEZES

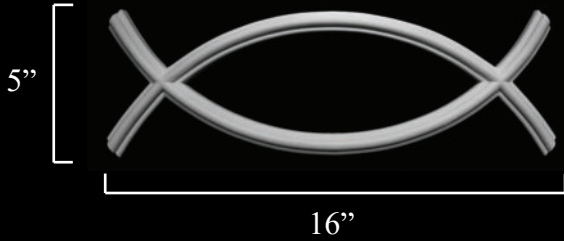

FRZ-162A  
16" x 5" x 1/2"

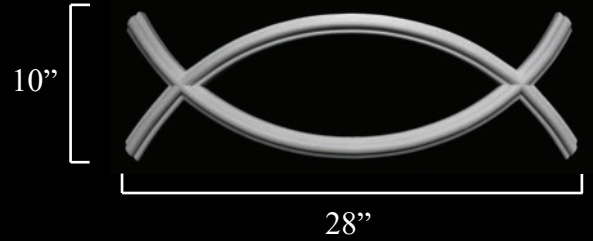

FRZ-162B  
28" x 10" x 1/2"

## Wallpanel Borders

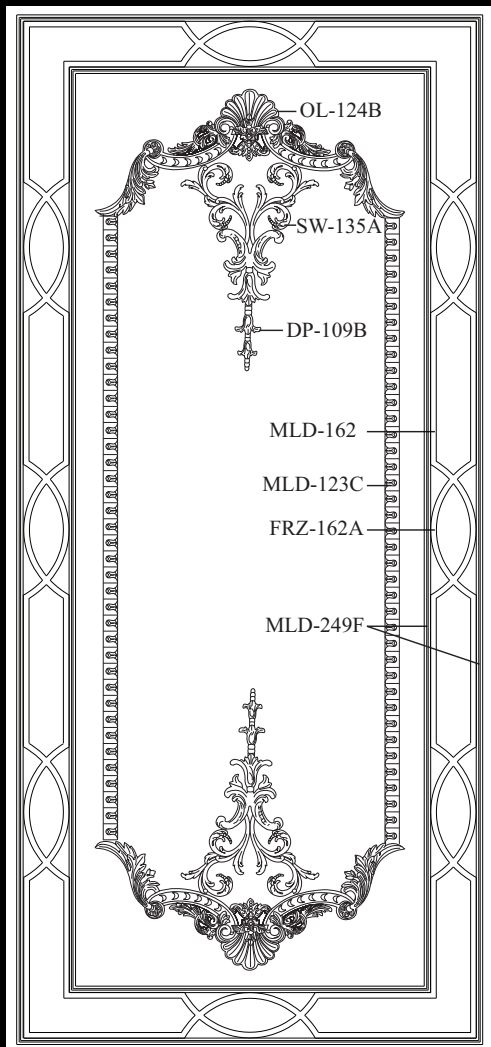

## Crown Build Ups

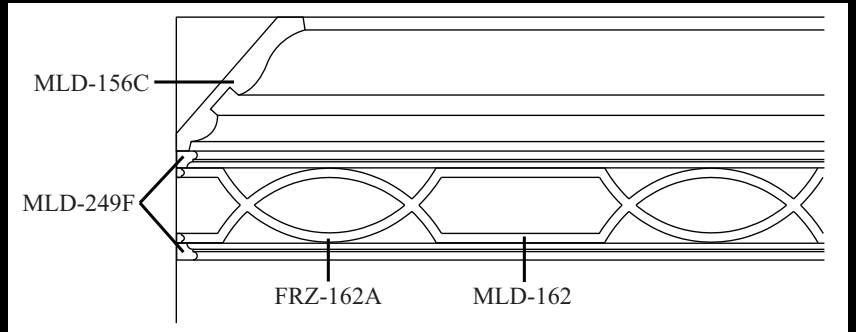

FRZ-162A Profile

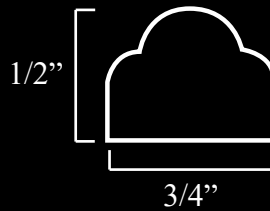

FRZ-162B Profile

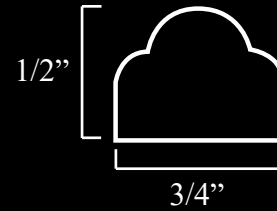

\*Use MLD-162 for staights.



# Ceiling Borders

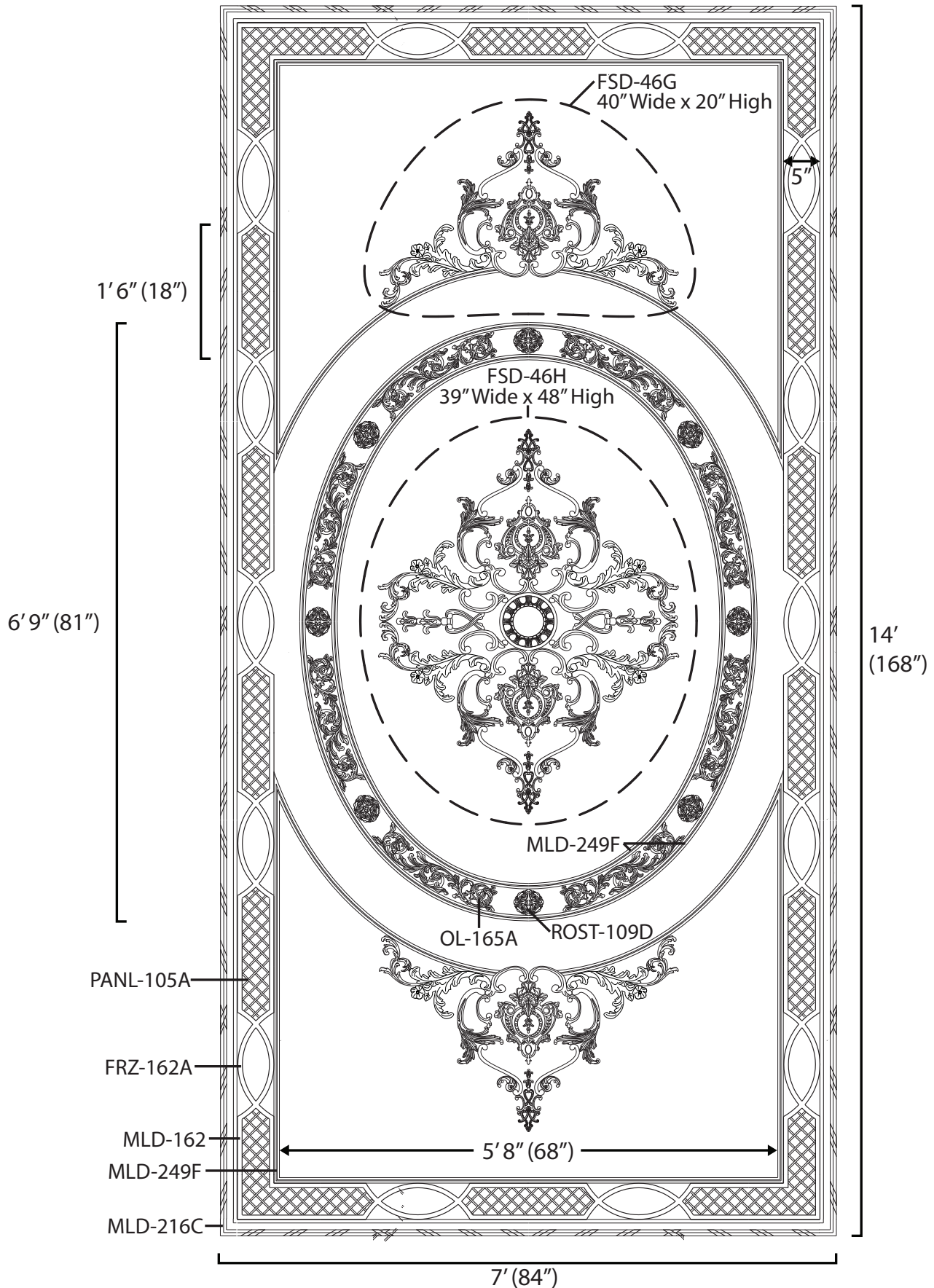

**FRIEZES**

\* All sizes are approx.- max W" x max Thickness" x max length"

# FRIEZES



FRZ-180  
5" x 1" x 8'  
17-1/2" repeat



FRZ-185  
3" x 1" x 8'  
9-3/4" repeat



FRZ-186  
5-1/2" x 1/2" x 6'



FRZ-188  
3" x 1" x 6'



FRZ-189  
3" x 1" x 6'



FRZ-190  
3" x 1" x 5'



FRZ-191  
3-3/4" x 1" x 5'

# FRIEZES



FRZ-192  
4" x 1" x 5'

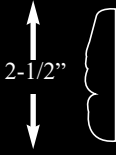

FRZ-193  
2-1/2" x 5/8" x 70"



FRZ-194A  
3-1/2" x 1/2" x 5'

FRZ-194B  
5-1/2" x 3/4" x 5'

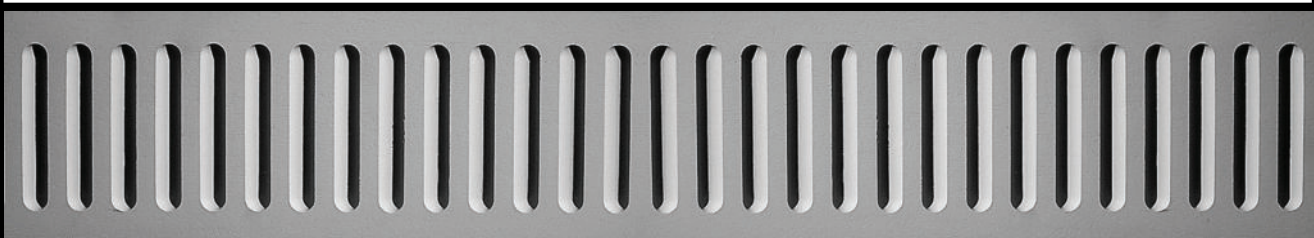

FRZ-200A 3-1/2" x 1/2" x 10'  
FRZ-200B 4-1/2" x 3/4" x 8'

FRZ-200C 6" x 3/4" x 10'  
FRZ-200D 7" x 3/4" x 10'

The new sizes of FRZ-200 and FRZ-201 (4 1/2" and 6") were specially made to be installed with our new series of center panels. FRZ-200B and FRZ-201B (4 1/2") works with PANL-210 and PANL-211 series. FRZ-200C and FRZ-201C (6") works with PANL-212 and PANL-213. Use these components together on cabinetry, valances, or door surrounds for a dramatic focal point that will complete a luxurious look.



FRZ-201B 4-1/2" x 3/4" x 8'  
FRZ-201C 6" x 3/4" x 8'

FRZ-201D 7" x 3/4" x 8'

# FRIEZES

All Resin Ornamentation is Flexible, Stainable & Paintable.



FF-160  
See Face Frames for details

*Introducing our  
New Line of Frieze Mouldings*

# CASTLE COLLECTION

INTELLIGENTLY PRICED



# 4" FRIEZE MOULDING

*Single Pattern • 5 Designs*



Design A

FRZ-404A



Design B

FRZ-404B



Design C

FRZ-404C



Design D

FRZ-404D



Design E

FRZ-404E

## 404 Series

### 4" Width

Thickness: 1"

#### Design Repeats:

FRZ-404A: 2-3/4"

FRZ-404B: 3-1/4"

FRZ-404C: 4"

FRZ-404D: 10-1/2"

FRZ-404E: 6-3/4"

Sold in random lengths.

Minimum length sold 5'.

Also available in Flex Resin.

Call for details.

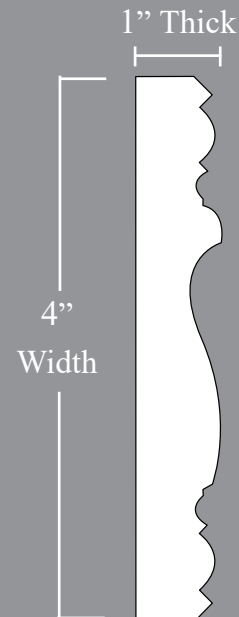

# 6" FRIEZE MOULDING

*Single Pattern • 5 Designs*



Design A

FRZ-406A



Design B

FRZ-406B



Design C

FRZ-406C



Design D

FRZ-406D



Design E

FRZ-406E

**406 Series**

**6" Width**

**Thickness: 1"**

**Design Repeats:**

FRZ-406A: 3-3/4"

FRZ-406B: 4-7/8"

FRZ-406C: 6-3/8"

FRZ-406D: 19"

FRZ-406E: 7-3/4"

Sold in random lengths.

Minimum length sold 5'.

**Also available in Flex Resin.**

**Call for details.**

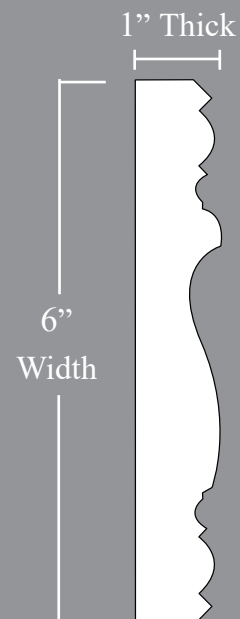

# 8" FRIEZE MOULDING

*Single Pattern • 4 Designs*



Design A

FRZ-408A



Design B

FRZ-408B



Design C

FRZ-408C



Design E

FRZ-408E

**408 Series**

**8" Width**

Thickness: 1"

**Design Repeats:**

FRZ-408A: 5-1/4"

FRZ-408B: 6-1/2"

FRZ-408C: 7-1/4"

FRZ-408E: 11"

Sold in random lengths.

Minimum length sold 5'.

**Also available in Flex Resin.  
Call for details.**

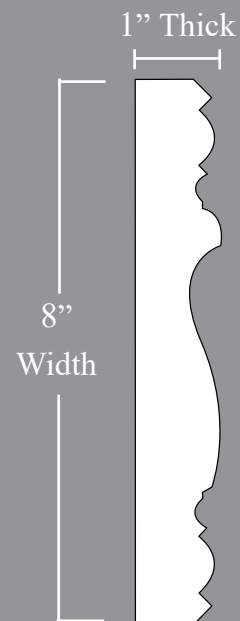



# 430-A Series 6-1/2" Width

Top Repeat: 3-3/4"  
Thickness: 1"

Sold in random lengths.  
Minimum length sold 5'.

Also available in Flex Resin.  
Call for details.

## FRIEZE MOULDING



\* Frieze bottom insert is not installed. This allows installer to better maximize pattern match.

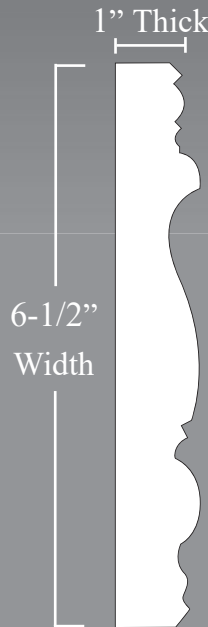

FRIEZES

# 430-B Series

## 6-1/2" Width

Top Repeat: 4-7/8"  
 Thickness: 1"

Sold in random lengths.  
 Minimum length sold 5'.

Also available in Flex Resin.  
 Call for details.

# FRIEZE MOULDING



FRZ-430B-1

Bottom Repeat: 1-3/4"  
 Bottom Insert: MLD-137C

\* Frieze bottom insert is not installed. This allows installer to better maximize pattern match.



FRZ-430B-2 Bottom Repeat: 7-1/2"  
 Bottom Insert: MLD-135C



FRZ-430B-4 Bottom Repeat: 4-1/2"  
 Bottom Insert: MLD-111C



FRZ-430B-6 Bottom Repeat: 7"  
 Bottom Insert: MLD-213C



FRZ-430B-8 Bottom Repeat: 1-1/4"  
 Bottom Insert: MLD-119CL

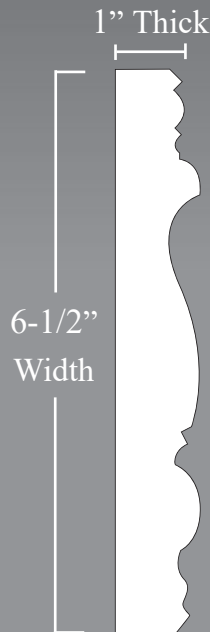

FRZ-430B-3 Bottom Repeat: 11-1/4"  
 Bottom Insert: MLD-204C



FRZ-430B-5 Bottom Repeat: 1-1/4"  
 Bottom Insert: MLD-103C



FRZ-430B-7 Bottom Repeat: 1-1/4"  
 Bottom Insert: MLD-123C



FRZ-430B-9 Bottom Repeat: 1-1/2"  
 Bottom Insert: MLD-139C

# FRIEZE MOULDING

## 430-C Series 6-1/2" Width

Top Repeat: 6"  
Thickness: 1"

Sold in random lengths.  
Minimum length sold 5'.

Also available in Flex Resin.  
Call for details.



\* Frieze bottom insert is not installed. This allows installer to better maximize pattern match.



FRZ-430C-2 Bottom Repeat: 7-1/2"  
Bottom Insert: MLD-135C



FRZ-430C-4 Bottom Repeat: 4-1/2"  
Bottom Insert: MLD-111C



FRZ-430C-6 Bottom Repeat: 7"  
Bottom Insert: MLD-213C



FRZ-430C-8 Bottom Repeat: 1-1/4"  
Bottom Insert: MLD-119CL

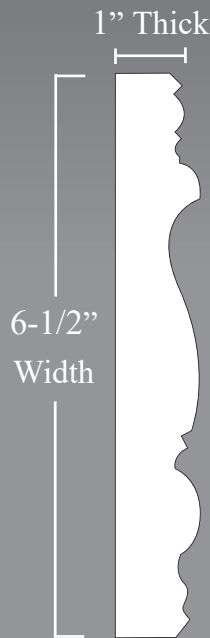

FRZ-430C-3 Bottom Repeat: 11-1/4"  
Bottom Insert: MLD-204C



FRZ-430C-5 Bottom Repeat: 1-1/4"  
Bottom Insert: MLD-103C



FRZ-430C-7 Bottom Repeat: 1-1/4"  
Bottom Insert: MLD-123C



FRZ-430C-9 Bottom Repeat: 1-1/2"  
Bottom Insert: MLD-139C

FRIEZES

# 430-D Series 6-1/2" Width

Top Repeat: 18"  
Thickness: 1"

Sold in random lengths.  
Minimum length sold 5'.

Also available in Flex Resin.  
Call for details.

# FRIEZE MOULDING



FRZ-430D-1

Bottom Repeat: 1-3/4"  
Bottom Insert: MLD-137C

\* Frieze bottom insert is not installed. This allows installer to better maximize pattern match.



FRZ-430D-2

Bottom Repeat: 7-1/2"  
Bottom Insert: MLD-135C



FRZ-430D-4

Bottom Repeat: 4-1/2"  
Bottom Insert: MLD-111C



FRZ-430D-6

Bottom Repeat: 7"  
Bottom Insert: MLD-213C



FRZ-430D-8

Bottom Repeat: 1-1/4"  
Bottom Insert: MLD-119CL



FRZ-430D-3

Bottom Repeat: 11-1/4"  
Bottom Insert: MLD-204C



FRZ-430D-5

Bottom Repeat: 1-1/4"  
Bottom Insert: MLD-103C



FRZ-430D-7

Bottom Repeat: 1-1/4"  
Bottom Insert: MLD-123C



FRZ-430D-9

Bottom Repeat: 1-1/2"  
Bottom Insert: MLD-139C

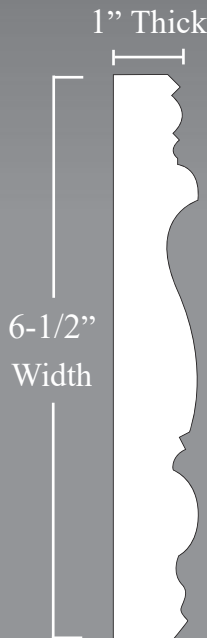

# 430-E Series 6-1/2" Width

Top Repeat: 11"  
Thickness: 1"

Sold in random lengths.  
Minimum length sold 5'.

Also available in Flex Resin.  
Call for details.

## FRIEZE MOULDING



FRZ-430E-1

Bottom Repeat: 1-3/4"  
Bottom Insert: MLD-137C

\* Frieze bottom insert is not installed. This allows installer to better maximize pattern match.



FRZ-430E-2

Bottom Repeat: 7-1/2"  
Bottom Insert: MLD-135C



FRZ-430E-4

Bottom Repeat: 4-1/2"  
Bottom Insert: MLD-111C



FRZ-430E-6

Bottom Repeat: 7"  
Bottom Insert: MLD-213C



FRZ-430E-8

Bottom Repeat: 1-1/4"  
Bottom Insert: MLD-119CL

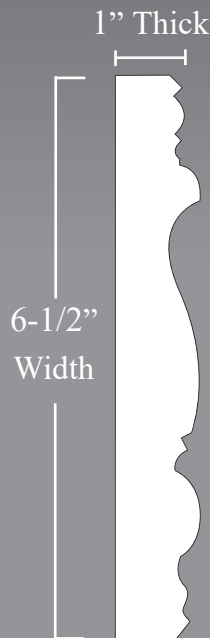

FRZ-430E-3

Bottom Repeat: 11-1/4"  
Bottom Insert: MLD-204C



FRZ-430E-5

Bottom Repeat: 1-1/4"  
Bottom Insert: MLD-103C



FRZ-430E-7

Bottom Repeat: 1-1/4"  
Bottom Insert: MLD-123C



FRZ-430E-9

Bottom Repeat: 1-1/2"  
Bottom Insert: MLD-139C

FRIEZES

# FRIEZE MOULDING

## 440-A Series 7-1/2" Width

Top Repeat: 2-3/4"  
Thickness: 1-1/4"

Sold in random lengths.  
Minimum length sold 5'.

Also available in Flex Resin.  
Call for details.



\* Frieze bottom insert is not installed. This allows installer to better maximize pattern match.

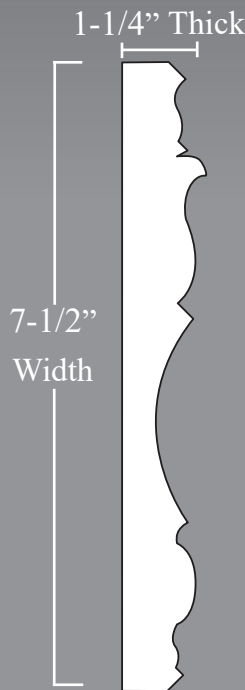

# 440-B Series 7-1/2" Width

Top Repeat: 3"  
Thickness: 1-1/4"

Sold in random lengths.  
Minimum length sold 5'.

Also available in Flex Resin.  
Call for details.

## FRIEZE MOULDING



FRZ-440B-1

Bottom Repeat: 1-3/4"  
Bottom Insert: MLD-137C

\* Frieze bottom insert is not installed. This allows installer to better maximize pattern match.



FRZ-440B-2 Bottom Repeat: 7-1/2"  
Bottom Insert: MLD-135C



FRZ-440B-4 Bottom Repeat: 4-1/2"  
Bottom Insert: MLD-111C



FRZ-440B-6 Bottom Repeat: 7"  
Bottom Insert: MLD-213C



FRZ-440B-8 Bottom Repeat: 1-1/4"  
Bottom Insert: MLD-119CL

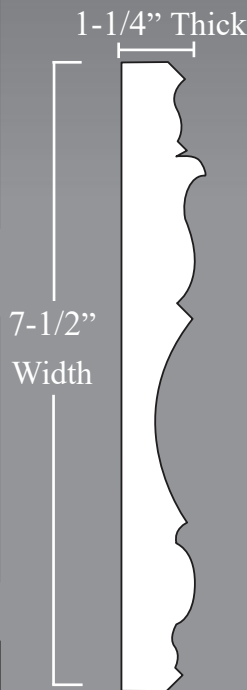

FRZ-440B-3 Bottom Repeat: 11-1/4"  
Bottom Insert: MLD-204C



FRZ-440B-5 Bottom Repeat: 1-1/4"  
Bottom Insert: MLD-103C



FRZ-440B-7 Bottom Repeat: 1-1/4"  
Bottom Insert: MLD-123C



FRZ-440B-9 Bottom Repeat: 1-1/2"  
Bottom Insert: MLD-139C



FRIEZES

# 440-C Series

## 7-1/2" Width

Top Repeat: 3-3/4"  
 Thickness: 1-1/4"

Sold in random lengths.  
 Minimum length sold 5'.

Also available in Flex Resin.  
 Call for details.

# FRIEZE MOULDING



\* Frieze bottom insert is not installed. This allows installer to better maximize pattern match.

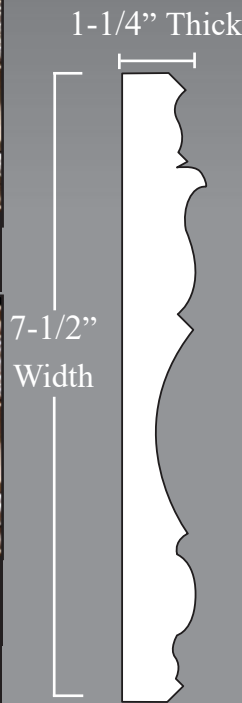



# 440-D Series

## 7-1/2" Width

Top Repeat: 10-1/2"  
 Thickness: 1-1/4"

Sold in random lengths.  
 Minimum length sold 5'.

Also available in Flex Resin.  
 Call for details.

# FRIEZE MOULDING



FRZ-440D-1

Bottom Repeat: 1-3/4"  
 Bottom Insert: MLD-137C

\* Frieze bottom insert is not installed. This allows installer to better maximize pattern match.



FRZ-440D-2 Bottom Repeat: 7-1/2"  
 Bottom Insert: MLD-135C



FRZ-440D-4 Bottom Repeat: 4-1/2"  
 Bottom Insert: MLD-111C



FRZ-440D-6 Bottom Repeat: 7"  
 Bottom Insert: MLD-213C



FRZ-440D-8 Bottom Repeat: 1-1/4"  
 Bottom Insert: MLD-119CL

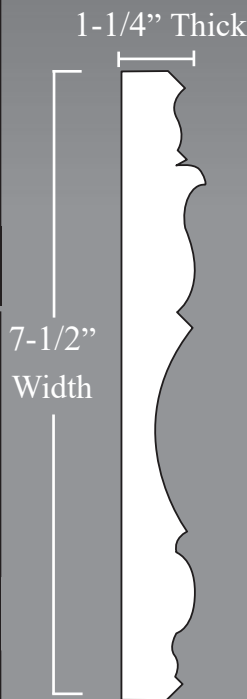

FRZ-440D-3 Bottom Repeat: 11-1/4"  
 Bottom Insert: MLD-204C



FRZ-440D-5 Bottom Repeat: 1-1/4"  
 Bottom Insert: MLD-103C



FRZ-440D-7 Bottom Repeat: 1-1/4"  
 Bottom Insert: MLD-123C



FRZ-440D-9 Bottom Repeat: 1-1/2"  
 Bottom Insert: MLD-139C



FRIEZES

# FRIEZE MOULDING

## 440-E Series 7-1/2" Width

**Top Repeat: 8"**  
**Thickness: 1-1/4"**

Sold in random lengths.  
Minimum length sold 5'.

Also available in Flex Resin.  
Call for details.



\* Frieze bottom insert is not installed. This allows installer to better maximize pattern match.

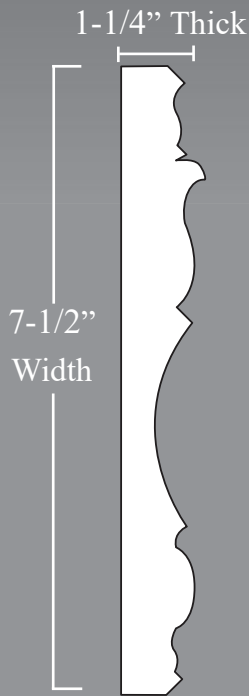

# FRIEZE MOULDING

## 480-A Series 10" Width

Top Repeat: 5-1/4"  
Thickness: 1-1/2"

Sold in random lengths.  
Minimum length sold 5'.

Also available in Flex Resin.  
Call for details.



\* Frieze bottom insert is not installed. This allows installer to better maximize pattern match.

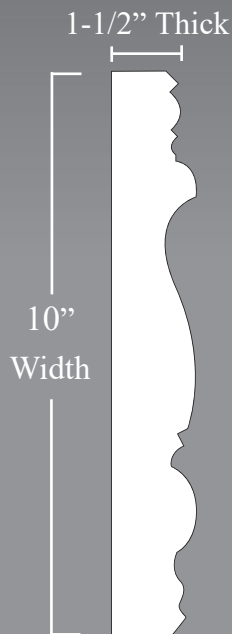

FRIEZES

# 480-B Series

## 10" Width

Top Repeat: 6-1/2"

Thickness: 1-1/2"

Sold in random lengths.  
Minimum length sold 5'.

Also available in Flex Resin.  
Call for details.

# FRIEZE MOULDING



FRZ-480B-1

Bottom Repeat: 2-1/2"  
Bottom Insert: MLD-137E

\* Frieze bottom insert is not installed. This allows installer to better maximize pattern match.



FRZ-480B-2

Bottom Repeat: 11-1/2"  
Bottom Insert: MLD-135D



FRZ-480B-4

Bottom Repeat: 5-1/4"  
Bottom Insert: MLD-111D



FRZ-480B-6

Bottom Repeat: 12"  
Bottom Insert: MLD-213D

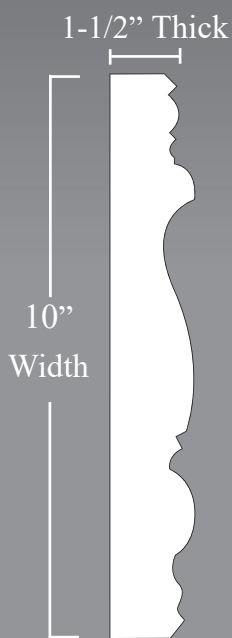

FRZ-480B-3

Bottom Repeat: 16-1/2"  
Bottom Insert: MLD-204D



FRZ-480B-5

Bottom Repeat: 2"  
Bottom Insert: MLD-103D



FRZ-480B-7

Bottom Repeat: 2"  
Bottom Insert: MLD-123D



FRZ-480B-8

Bottom Repeat: 2-1/4"  
Bottom Insert: MLD-119DL

# 480-C Series 10" Width

Top Repeat: 7-1/4"  
Thickness: 1-1/2"

Sold in random lengths.  
Minimum length sold 5'.

Also available in Flex Resin.  
Call for details.

# FRIEZE MOULDING



FRZ-480C-1

Bottom Repeat: 2-1/2"  
Bottom Insert: MLD-137E

\* Frieze bottom insert is not installed. This allows installer to better maximize pattern match.



FRZ-480C-2 Bottom Repeat: 11-1/2"  
Bottom Insert: MLD-135D



FRZ-480C-4 Bottom Repeat: 5-1/4"  
Bottom Insert: MLD-111D



FRZ-480C-6 Bottom Repeat: 12"  
Bottom Insert: MLD-213D

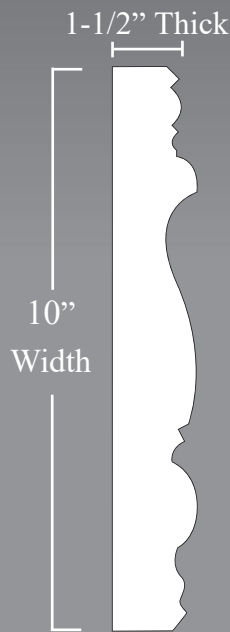

FRZ-480C-3 Bottom Repeat: 16-1/2"  
Bottom Insert: MLD-204D



FRZ-480C-5 Bottom Repeat: 2"  
Bottom Insert: MLD-103D



FRZ-480C-7 Bottom Repeat: 2"  
Bottom Insert: MLD-123D



FRZ-480C-8 Bottom Repeat: 2-1/4"  
Bottom Insert: MLD-119DL

FRIEZES

# 480-E Series

## 10" Width

Top Repeat: 11"  
Thickness: 1-1/2"

Sold in random lengths.  
Minimum length sold 5'.

Also available in Flex Resin.  
Call for details.

# FRIEZE MOULDING



\* Frieze bottom insert is not installed. This allows installer to better maximize pattern match.

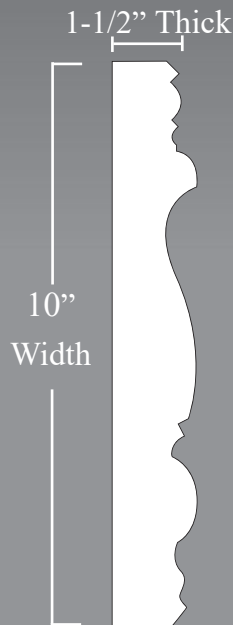

# FRIEZES

All Resin Ornamentation is Flexible, Stainable & Paintable.



FRIEZES

Our new modular size friezes are engineered for use with center panels and plinth blocks.

# 3-1/2" Frieze Stretcher Assembly

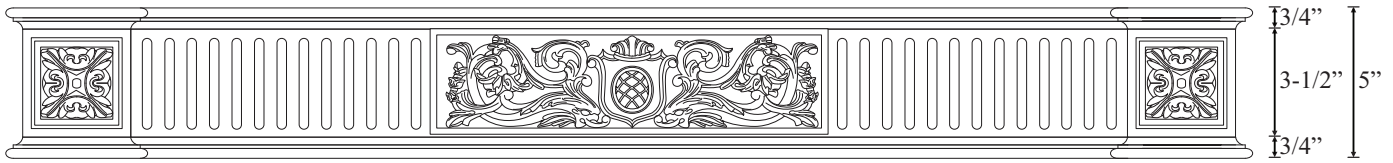

Moulding (MLD-249F) wraps around plinth block.

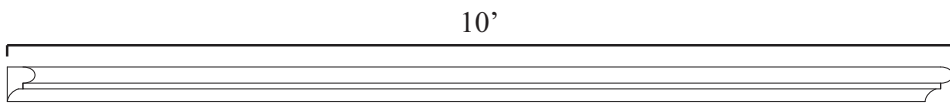
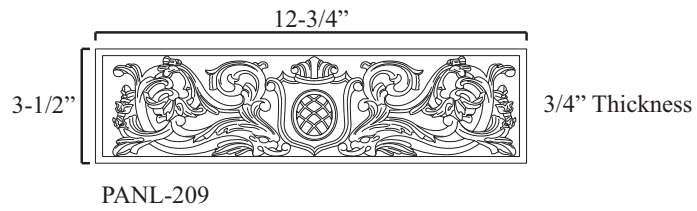
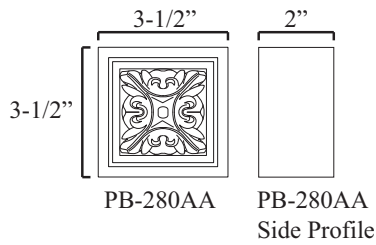
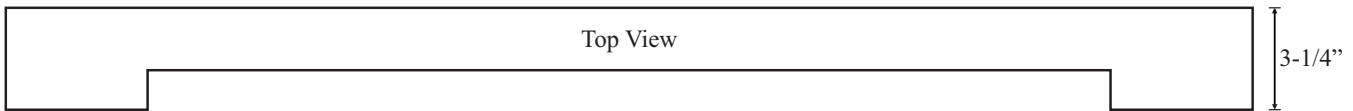

MLD-249F Sold in 10' Lengths

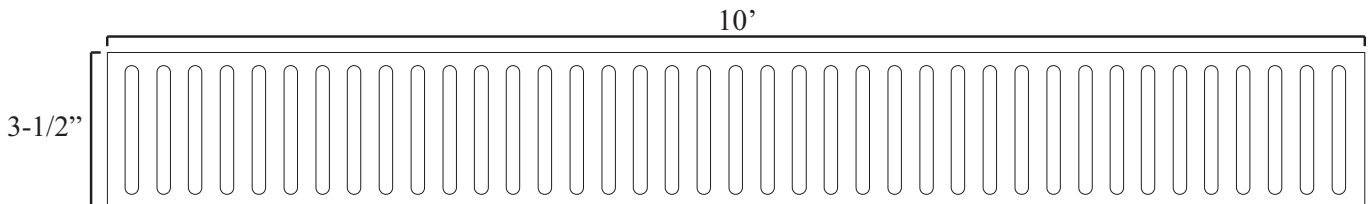
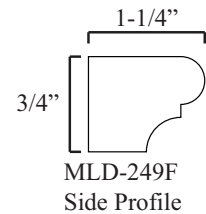

FRZ-200A



# 4-1/2" Frieze Stretcher Assembly

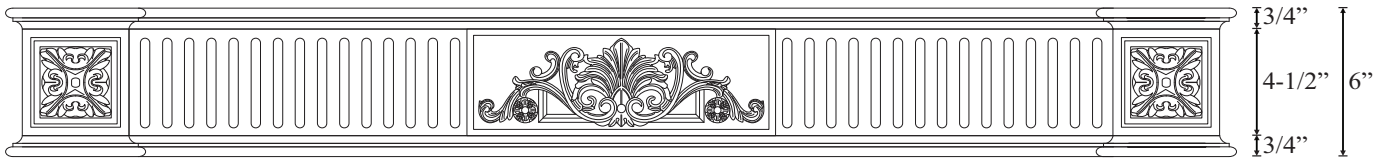

Moulding (MLD-249F) wraps around plinth block.

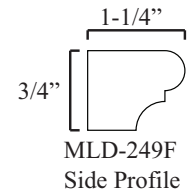
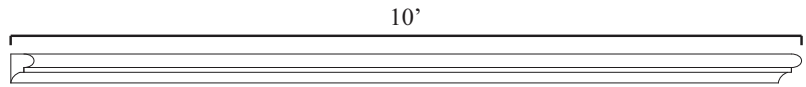
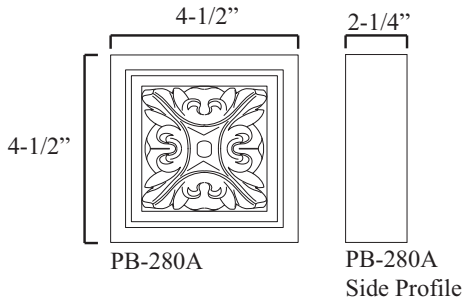
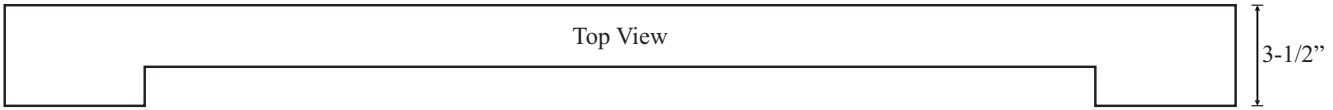

## OPTIONAL CENTER PANELS

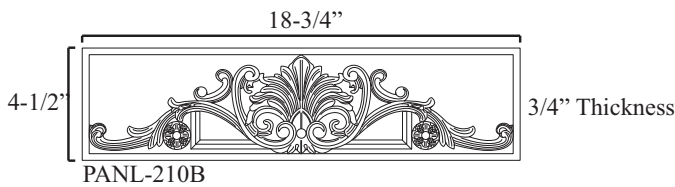

## OPTIONAL FRIEZE PANELS

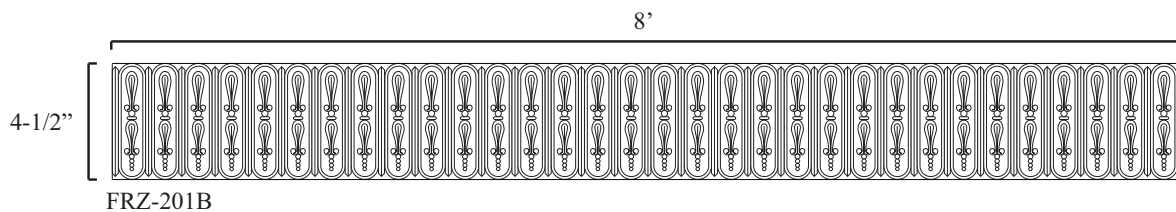
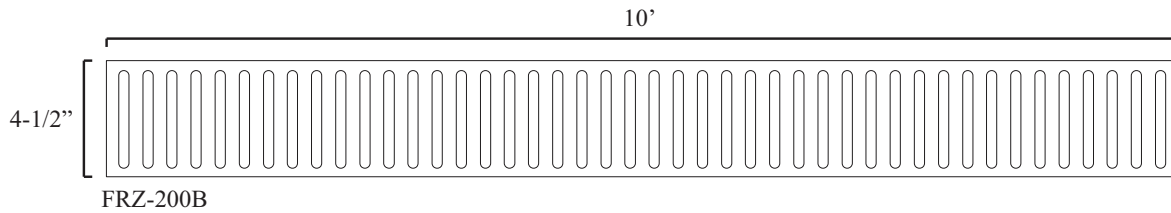

# 6" Frieze Stretcher Assembly



Moulding (MLD-249F) wraps around plinth block.

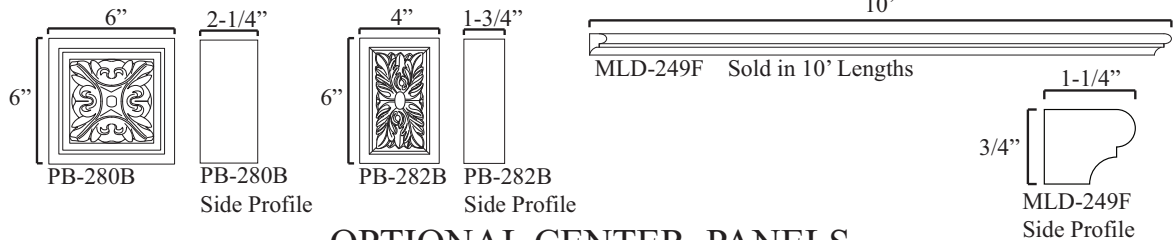
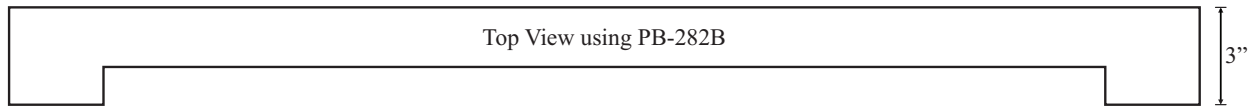
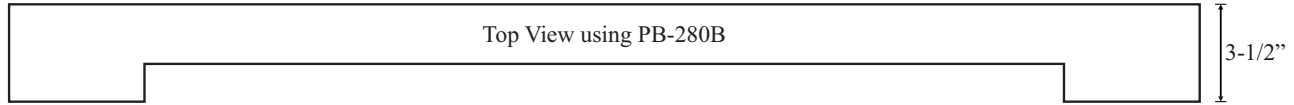

## OPTIONAL CENTER PANELS

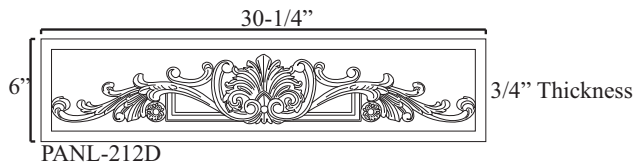
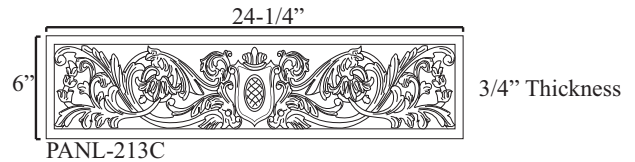
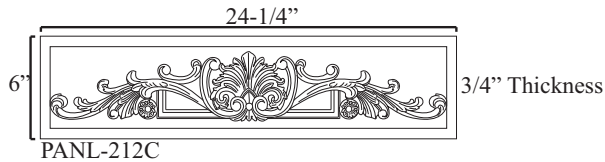
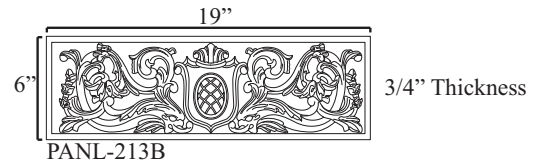
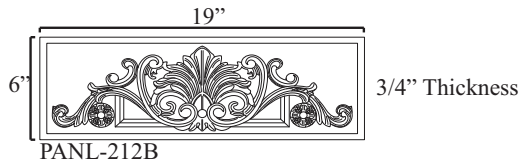

## OPTIONAL FRIEZE PANELS

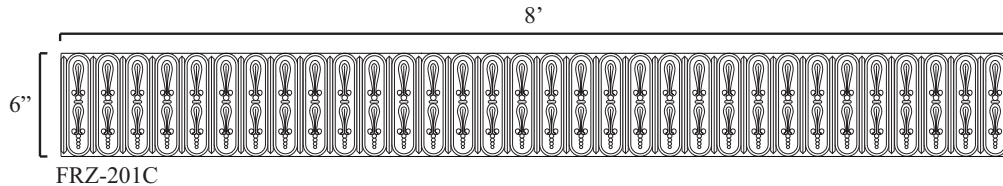
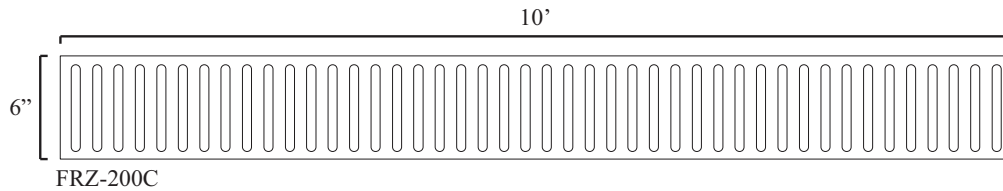

# 7" Frieze Stretcher Assembly

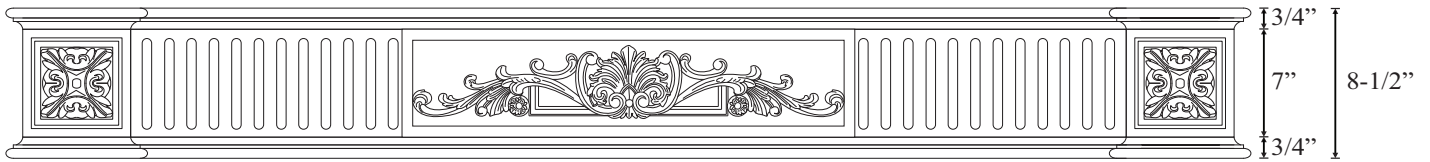

Moulding (MLD-249F) wraps around plinth block.

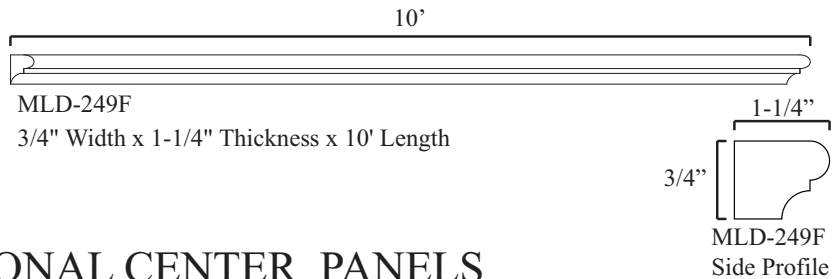
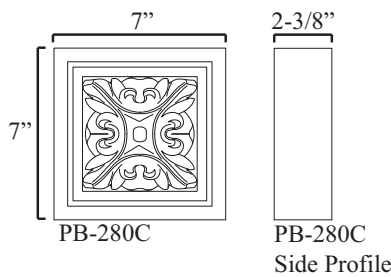
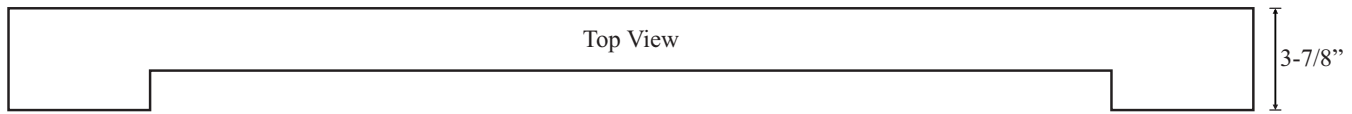

## OPTIONAL CENTER PANELS

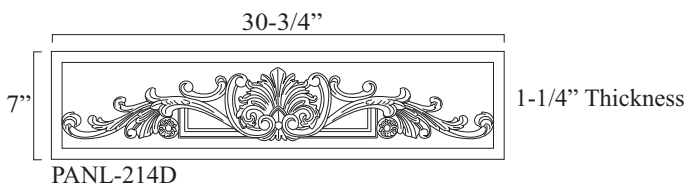
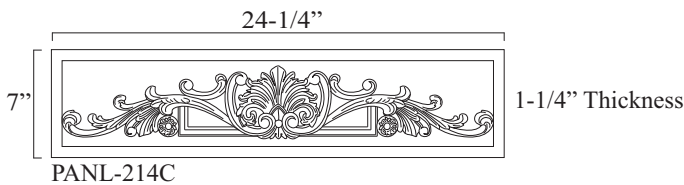

## OPTIONAL FRIEZE PANELS

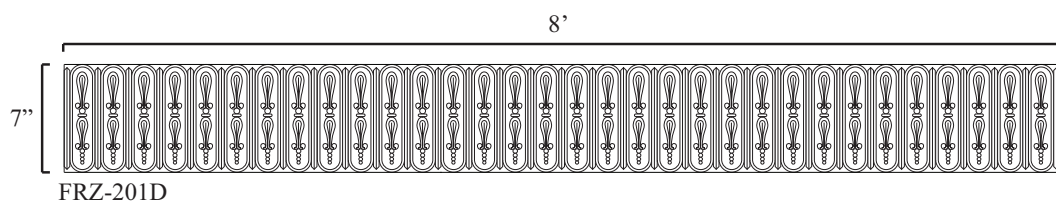
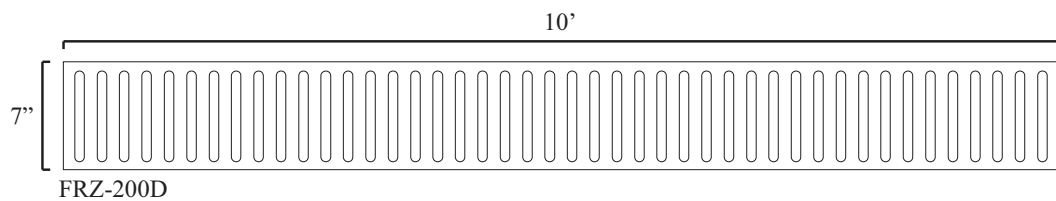

# FRIEZE PRICE LIST

#	Part Number	Price
1	FRZ-100	\$54.95
2	FRZ-101	\$153.95
3	FRZ-103	\$54.95
4	FRZ-104	\$98.95
5	FRZ-105	\$98.95
6	FRZ-106	\$131.95
7	FRZ-107	\$87.95
8	FRZ-110	\$54.95
9	FRZ-111	\$142.95
10	FRZ-115A	\$189.95
11	FRZ-115B	\$219.95
12	FRZ-117A	\$87.95
13	FRZ-117B	\$98.95
14	FRZ-118	\$98.95
15	FRZ-120B	\$274.95
16	FRZ-162A	\$27.95
17	FRZ-162B	\$38.95
18	FRZ-180	\$109.95
19	FRZ-185	\$87.95
20	FRZ-186	\$142.95
21	FRZ-188	\$99.95
22	FRZ-189	\$99.95
23	FRZ-190	\$79.95
24	FRZ-191	\$98.95
25	FRZ-192	\$98.95
26	FRZ-193	\$87.95
27	FRZ-194A	\$76.95
28	FRZ-194B	\$87.95
29	FRZ-200A	\$109.95
30	FRZ-200B	\$109.95
31	FRZ-200C	\$153.95
32	FRZ-200D	\$175.95
33	FRZ-201B	\$142.95
34	FRZ-201C	\$164.95
35	FRZ-201D	\$186.95

#	Part Number	Price
36	FRZ-404A	\$14.95
37	FRZ-404A FLEX	\$25.95
38	FRZ-404B	\$14.95
39	FRZ-404B FLEX	\$25.95
40	FRZ-404C	\$14.95
41	FRZ-404C FLEX	\$25.95
42	FRZ-404D	\$14.95
43	FRZ-404D FLEX	\$25.95
44	FRZ-404E	\$14.95
45	FRZ-404E FLEX	\$25.95
46	FRZ-406A	\$17.95
47	FRZ-406A FLEX	\$28.95
48	FRZ-406B	\$17.95
49	FRZ-406B FLEX	\$28.95
50	FRZ-406C	\$17.95
51	FRZ-406C FLEX	\$28.95
52	FRZ-406D	\$17.95
53	FRZ-406D FLEX	\$28.95
54	FRZ-406E	\$17.95
55	FRZ-406E FLEX	\$28.95
56	FRZ-408A	\$25.95
57	FRZ-408A FLEX	\$32.95
58	FRZ-408B	\$25.95
59	FRZ-408B FLEX	\$32.95
60	FRZ-408C	\$25.95
61	FRZ-408C FLEX	\$32.95
62	FRZ-408E	\$25.95
63	FRZ-408E FLEX	\$32.95
64	FRZ-430A-1	\$18.95
65	FRZ-430A-2	\$18.95
66	FRZ-430A-3	\$18.95
67	FRZ-430A-4	\$18.95
68	FRZ-430A-5	\$18.95
69	FRZ-430A-6	\$18.95
70	FRZ-430A-7	\$18.95

#	Part Number	Price
71	FRZ-430A-8	\$18.95
72	FRZ-430A-9	\$18.95
73	FRZ-430A FLEX	\$25.95
74	FRZ-430B-1	\$18.95
75	FRZ-430B-2	\$18.95
76	FRZ-430B-3	\$18.95
77	FRZ-430B-4	\$18.95
78	FRZ-430B-5	\$18.95
79	FRZ-430B-6	\$18.95
80	FRZ-430B-7	\$18.95
81	FRZ-430B-8	\$18.95
82	FRZ-430B-9	\$18.95
83	FRZ-430B FLEX	\$25.95
84	FRZ-430C-1	\$18.95
85	FRZ-430C-2	\$18.95
86	FRZ-430C-3	\$18.95
87	FRZ-430C-4	\$18.95
88	FRZ-430C-5	\$18.95
89	FRZ-430C-6	\$18.95
90	FRZ-430C-7	\$18.95
91	FRZ-430C-8	\$18.95
92	FRZ-430C-9	\$18.95
93	FRZ-430C FLEX	\$25.95
94	FRZ-430D-1	\$18.95
95	FRZ-430D-2	\$18.95
96	FRZ-430D-3	\$18.95
97	FRZ-430D-4	\$18.95
98	FRZ-430D-5	\$18.95
99	FRZ-430D-6	\$18.95
100	FRZ-430D-7	\$18.95
101	FRZ-430D-8	\$18.95
102	FRZ-430D-9	\$18.95
103	FRZ-430D FLEX	\$25.95
104	FRZ-430E-1	\$18.95
105	FRZ-430E-2	\$18.95

# FRIEZE PRICE LIST

#	Part Number	Price
106	FRZ-430E-3	\$18.95
107	FRZ-430E-4	\$18.95
108	FRZ-430E-5	\$18.95
109	FRZ-430E-6	\$18.95
110	FRZ-430E-7	\$18.95
111	FRZ-430E-8	\$18.95
112	FRZ-430E-9	\$18.95
113	FRZ-440A-1	\$19.95
114	FRZ-440A-2	\$19.95
115	FRZ-440A-3	\$19.95
116	FRZ-440A-4	\$19.95
117	FRZ-440A-5	\$19.95
118	FRZ-440A-6	\$19.95
119	FRZ-440A-7	\$19.95
120	FRZ-440A-8	\$19.95
121	FRZ-440A-9	\$19.95
122	FRZ-440A FLEX	\$29.95
123	FRZ-440B-1	\$19.95
124	FRZ-440B-2	\$19.95
125	FRZ-440B-3	\$19.95
126	FRZ-440B-4	\$19.95
127	FRZ-440B-5	\$19.95
128	FRZ-440B-6	\$19.95
129	FRZ-440B-7	\$19.95
130	FRZ-440B-8	\$19.95
131	FRZ-440B-9	\$19.95
132	FRZ-440C-1	\$19.95
133	FRZ-440C-2	\$19.95
134	FRZ-440C-3	\$19.95
135	FRZ-440C-4	\$19.95
136	FRZ-440C-5	\$19.95
137	FRZ-440C-6	\$19.95
138	FRZ-440C-7	\$19.95
139	FRZ-440C-8	\$19.95
140	FRZ-440C-9	\$19.95

#	Part Number	Price
141	FRZ-440D-1	\$19.95
142	FRZ-440D-2	\$19.95
143	FRZ-440D-3	\$19.95
144	FRZ-440D-4	\$19.95
145	FRZ-440D-5	\$19.95
146	FRZ-440D-6	\$19.95
147	FRZ-440D-7	\$19.95
148	FRZ-440D-8	\$19.95
149	FRZ-440D-9	\$19.95
150	FRZ-440D FLEX	\$29.95
151	FRZ-440E-1	\$19.95
152	FRZ-440E-2	\$19.95
153	FRZ-440E-3	\$19.95
154	FRZ-440E-4	\$19.95
155	FRZ-440E-5	\$19.95
156	FRZ-440E-6	\$19.95
157	FRZ-440E-7	\$19.95
158	FRZ-440E-8	\$19.95
159	FRZ-440E-9	\$19.95
160	FRZ-480A-1	\$36.95
161	FRZ-480A-2	\$36.95
162	FRZ-480A-3	\$36.95
163	FRZ-480A-4	\$36.95
164	FRZ-480A-5	\$36.95
165	FRZ-480A-6	\$36.95
166	FRZ-480A-7	\$36.95
167	FRZ-480A-8	\$36.95
168	FRZ-480A FLEX	\$45.95
169	FRZ-480B-1	\$36.95
170	FRZ-480B-2	\$36.95
171	FRZ-480B-3	\$36.95
172	FRZ-480B-4	\$36.95
173	FRZ-480B-5	\$36.95
174	FRZ-480B-6	\$36.95
175	FRZ-480B-7	\$36.95

#	Part Number	Price
176	FRZ-480B-8	\$36.95
177	FRZ-480C-1	\$36.95
178	FRZ-480C-2	\$36.95
179	FRZ-480C-3	\$36.95
180	FRZ-480C-4	\$36.95
181	FRZ-480C-5	\$36.95
182	FRZ-480C-6	\$36.95
183	FRZ-480C-7	\$36.95
184	FRZ-480C-8	\$36.95
185	FRZ-480E-1	\$36.95
186	FRZ-480E-2	\$36.95
187	FRZ-480E-3	\$36.95
188	FRZ-480E-4	\$36.95
189	FRZ-480E-5	\$36.95
190	FRZ-480E-6	\$36.95
191	FRZ-480E-7	\$36.95
192	FRZ-480E-8	\$36.95
193	FRZ-F-120B	\$179.95

# FRIEZES

All Resin Ornamentation is Flexible, Stainable & Paintable.



Pearlworks flexible friezes can be custom made to fit most any radius.