

# Wallpanels



Pearlworks, Inc. 14251 Franklin Ave. Tustin, CA 92780  
Office: (714) 573-1700 Fax: (714) 573-1708 Toll Free: (855) PEARLWORKS  
[www.pearlworksinc.com](http://www.pearlworksinc.com)



## FREESTYLE AND PRECAST PANELS

Pearlworks over the years developed a simple modular system and applied it to wallpanel designs. We have taken the complex and simplified it. Take a look at our wall panel offerings to see which system works best for your project.

Pearlworks offers two types of flexible wall panels, FREESTYLE and PRECAST.

### FLEXIBLE FREE STYLE WALL PANELS



Freestyle wallpanels have some very unique and useful positives for designers and carpenters. The wall panels come with all flexible components not attached together. This allows maximum adjustability for width and height. Because the individual components are flexible, they are easily moved to create overlapping connections. It also allows you to change the shape of each component and apply them to curved surfaces.

### FLEXIBLE PRE CAST WALL PANELS

CT-204A



Our flexible pre cast panels were designed for ultimate ease of installation and cost savings. Each flexible wall panel typically comes as a 4 piece set. You will get an upper and lower pre cast design along with two connection moldings.

Pre cast wall panels are designed to be installed in less than one hour, on any flat or curved surface. No other wall panel on--- the market can do this.

Pre cast wall panels only have height adjustibility.

**\* Call for radius limits.**

VERSAILLES THREE PANEL SET

WALL PANELS



# Exploded View for 34" Wide Versailles Panels

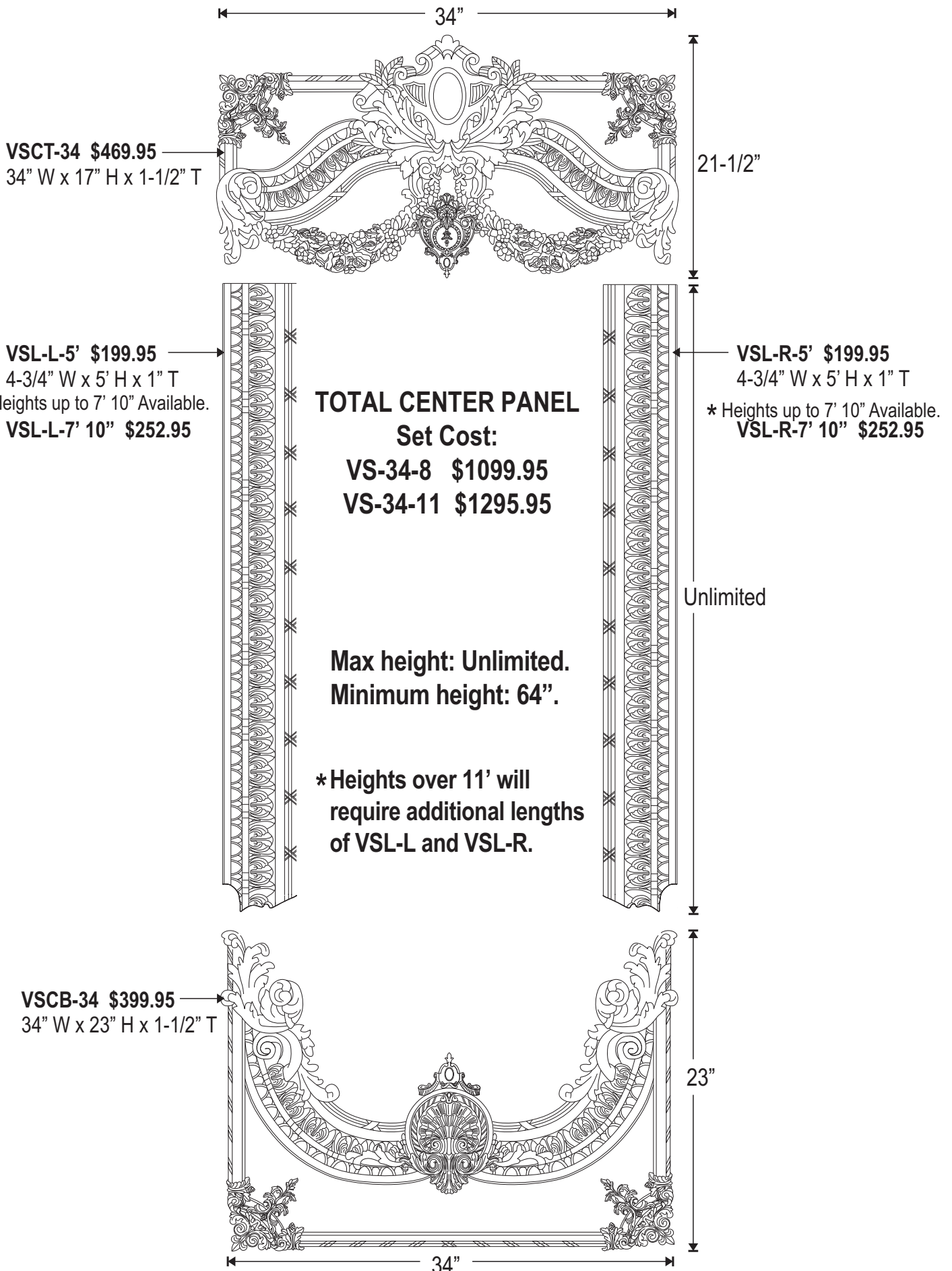

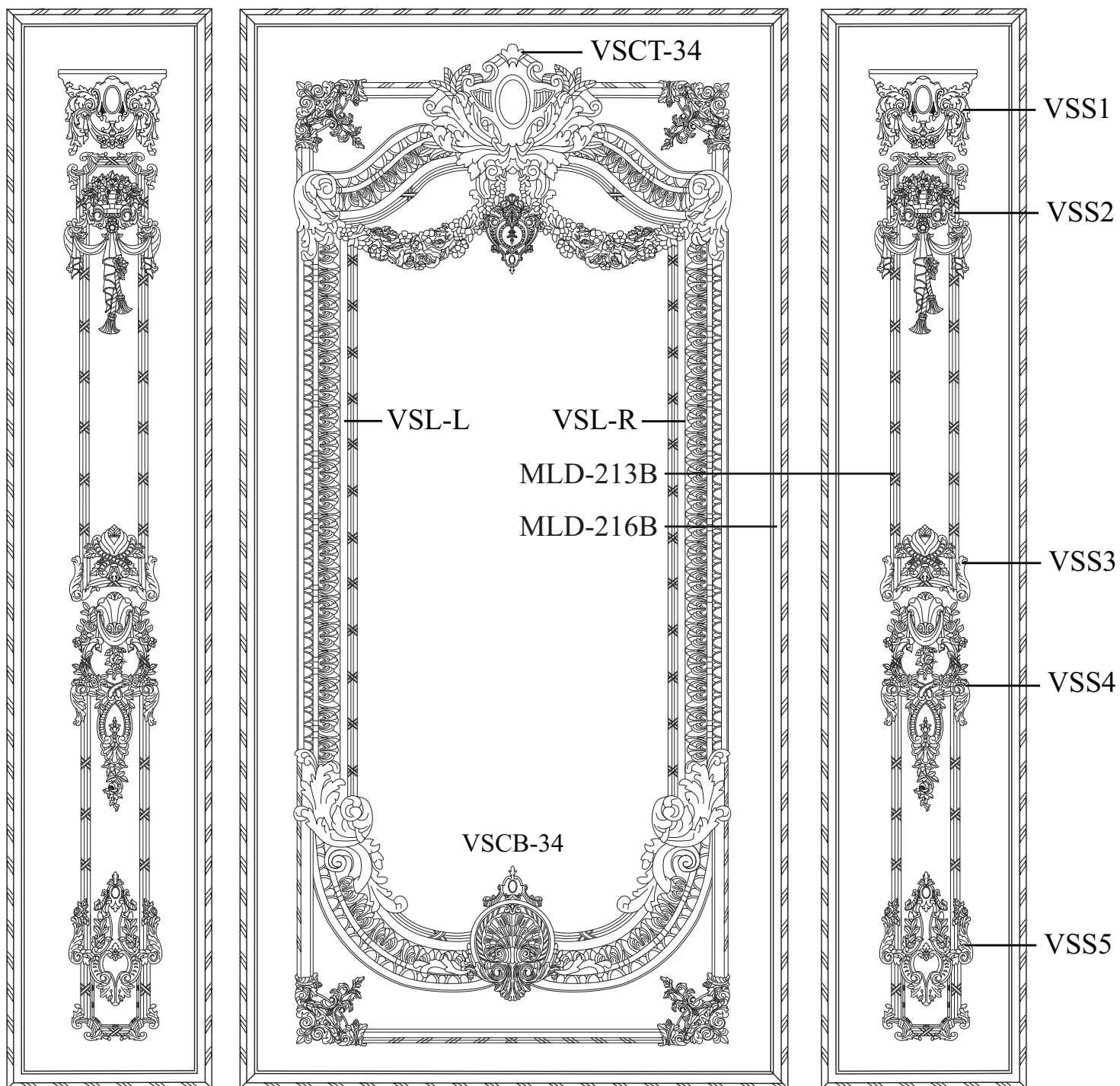

\* All sizes are approx.- max W” x max H” x Thickness”

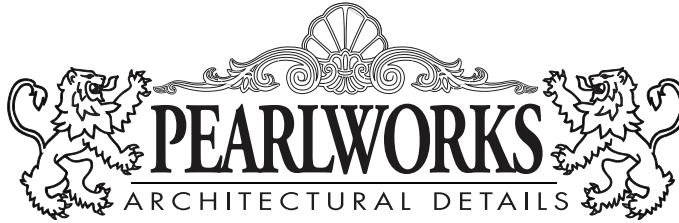

Toll Free: (855)-PEARLWORKS Website: pearlworksinc.com

THREE WALLPANEL COMBINATION WP3P-4A

\*Panel Height And Width Are Adjustable.

\*Multiple Pieces Assembly Required

\*Price Will Vary Depending On Panel Width And Height.

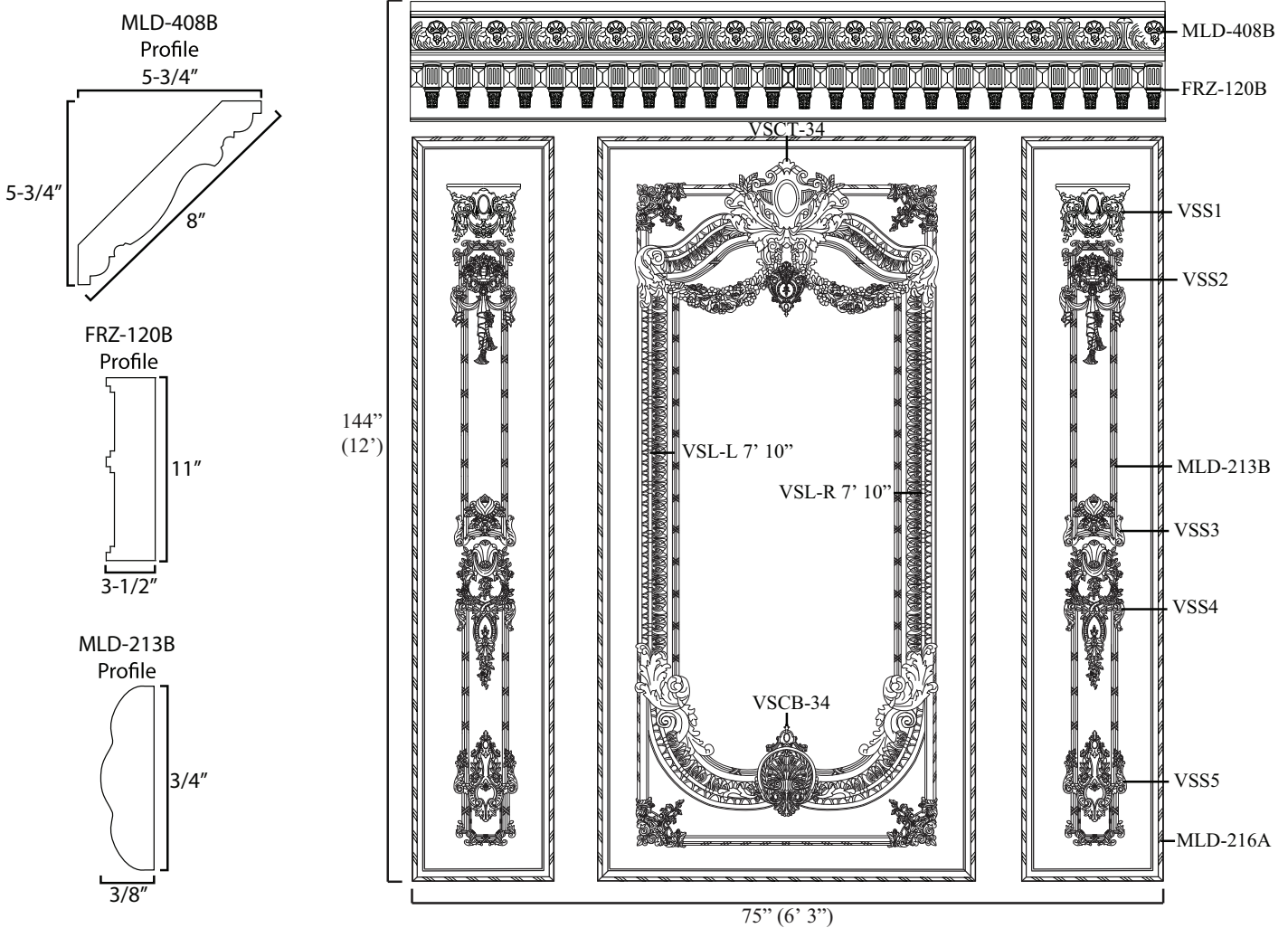

QTY	PART LIST	PRICE
7'	MLD-408B	176.75
10'	FRZ-120B	549.90
1	VSCB-34	472.95 Ea.
1	VSL-L-7' 10"	252.95 Ea.
1	VSL-R-7' 10"	252.95 Ea.
1	VSCB-34	417.95 Ea.
2	VSS1	274.90

QTY	PART LIST	PRICE
2	VSS2	373.90
20'	MLD-213B	109.90
2	VSS3	263.90
2	VSS4	417.90
2	VSS5	329.90
80'	MLD-216A	615.60
	<b>Total Cost</b>	<b>4509.45</b>

\*"THIS IS NOT A BUILD DRAWING". All drawings are "CONCEPT ONLY" and should be used as such.

\*Projects built from concept drawings will "ALWAYS" vary due to unforeseen installation and field measurement changes.

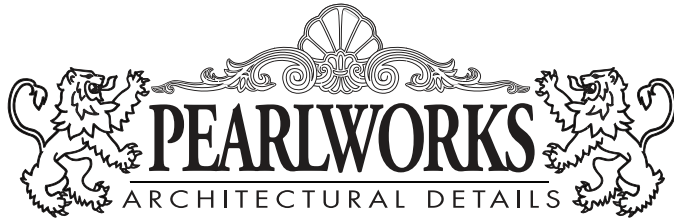

Toll Free: (855)-PEARLWORKS Website: pearlworksin.com

THREE WALLPANEL COMBINATION WP3P-4F

- \*Please Note All Written Measurements Are Approximate And Not Exact.
- \*Easy Adjustments To Height.
- \*Price Can Vary Depending On Panel Height.

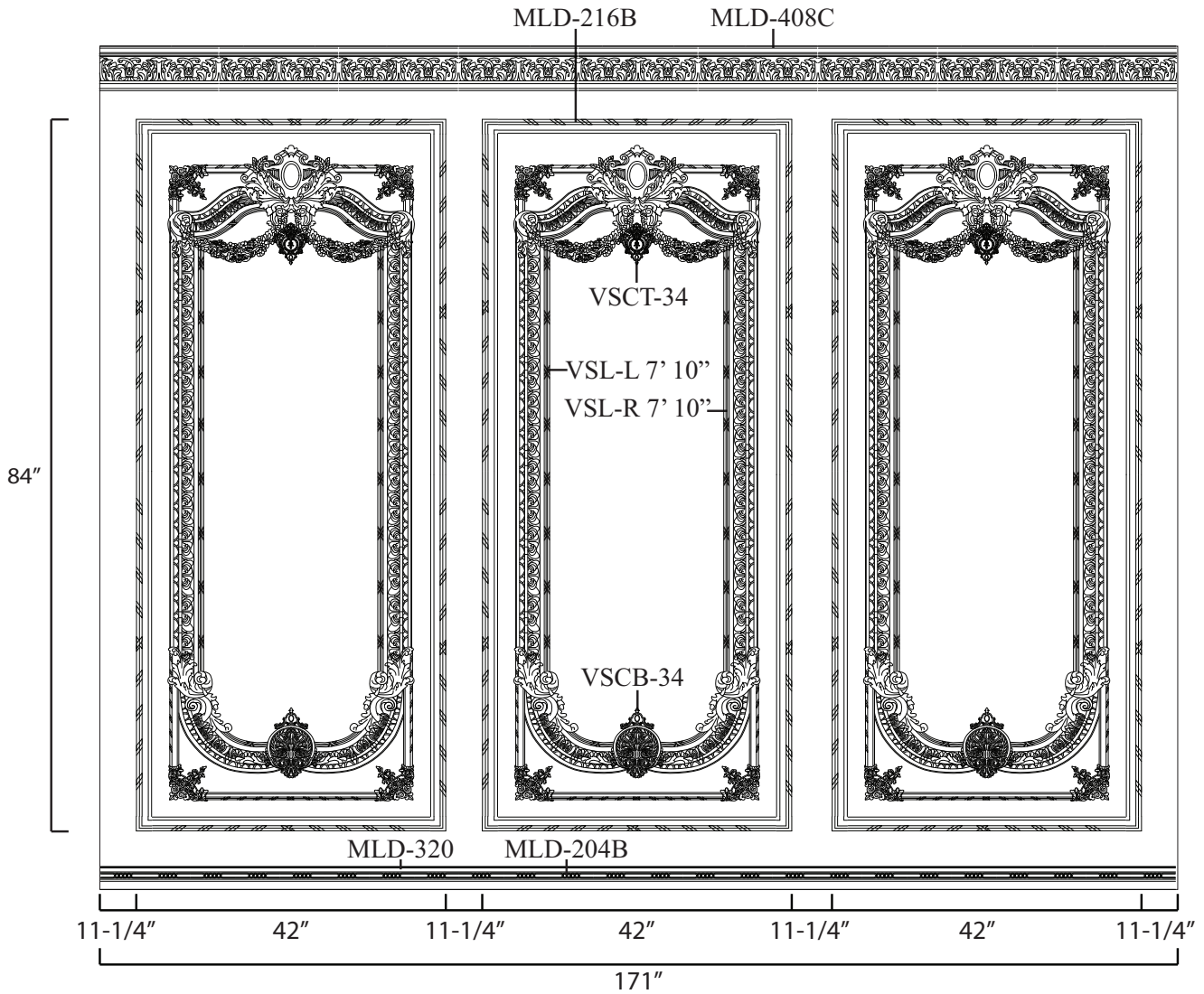

QTY	PART LIST	PRICE
70'	MLD-216B	615.65
15'	MLD-408C	378.75
3	VSCT-34	1418.85
3	VSL-7' 10"	758.85
3	VSR-7' 10"	758.85

QTY	PART LIST	PRICE
3	VSCB-34	1253.85
15'	MLD-320	312.75
20'	MLD-204B	109.90
	Total Cost	5607.45

\*"THIS IS NOT A BUILD DRAWING". All drawings are "CONCEPT ONLY" and should be used as such.

\*Projects built from concept drawings will "ALWAYS" vary due to unforeseen installation and field measurement changes.

\* All sizes are approx.- max W" x max H" x Thickness"

# 54" Expanded to 73" Wide Versailles Panel





Toll Free: (855)-PEARLWORKS Website: pearlworksinc.com

THREE WALLPANEL COMBINATION WP3P-4H

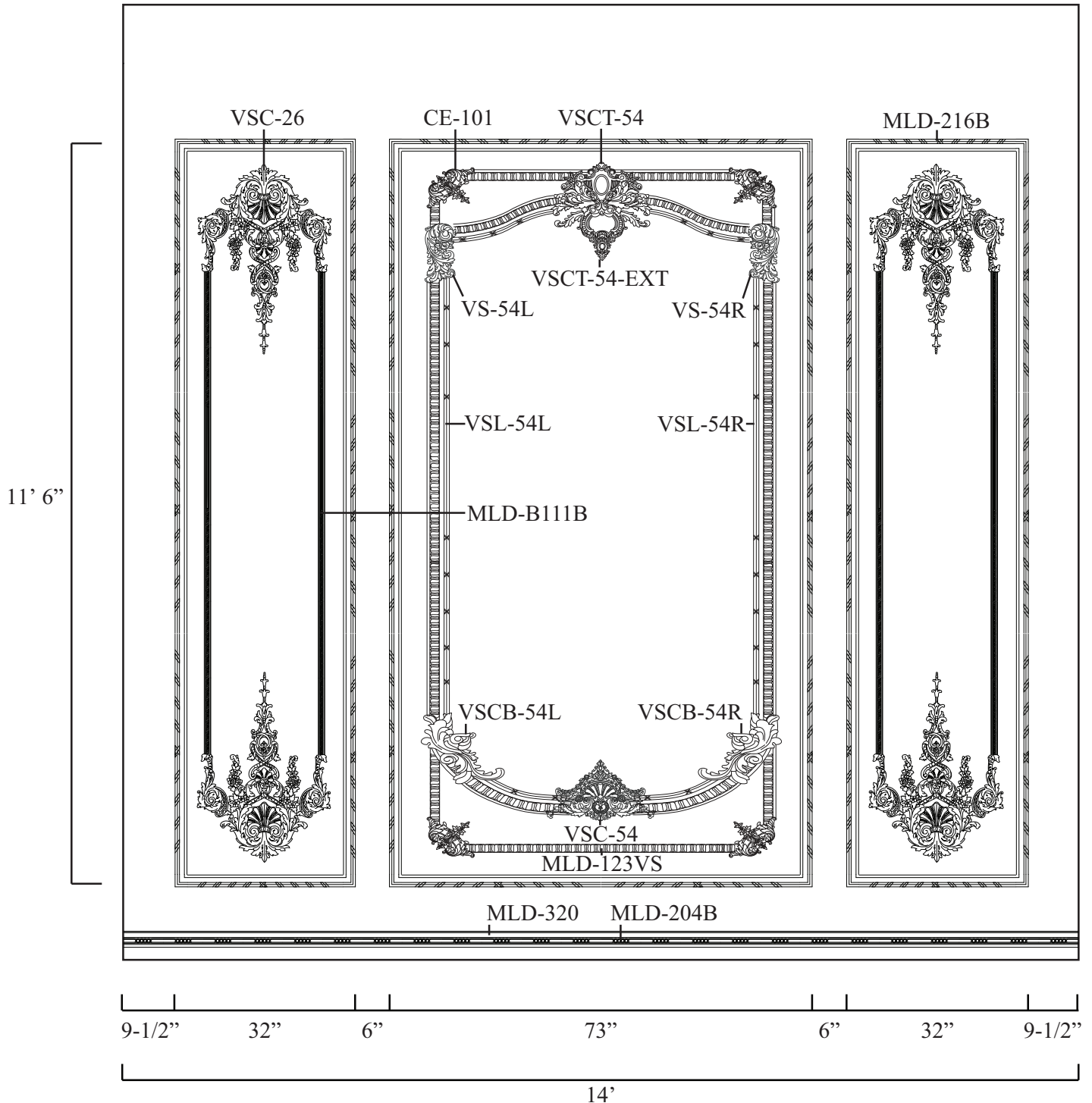

\*"THIS IS NOT A BUILD DRAWING". All drawings are "CONCEPT ONLY" and should be used as such.

\*Projects built from concept drawings will "ALWAYS" vary due to unforeseen installation and field measurement changes.

\* All sizes are approx.- max W" x max H" x Thickness"

# Exploded View for 54" - 73' Wide Versailles Panel

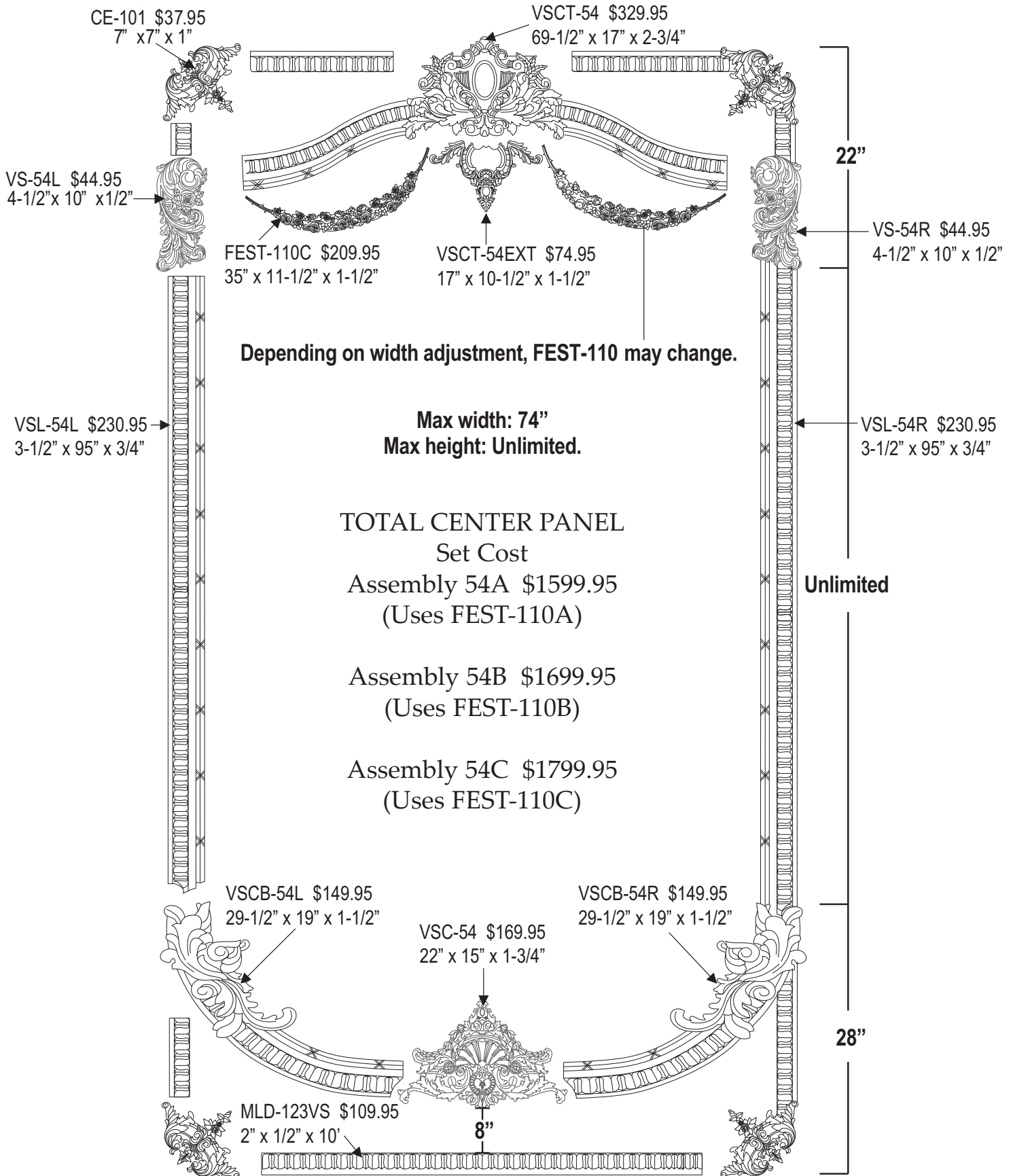

# 54" - 73" Wide Versailles Panel



Toll Free: (855)-PEARLWORKS Website: pearlworksinc.com

## VERSAILLES WALLPANEL WP54-1A

- \*Please Note All Written Measurements Are Approximate And Not Exact.
- \*Flexible Sub-Components Along With How You Lay Out The Design Allow Easy Adjustments To Width.
- \*Price Can Vary Depending On Panel Height.
- \*Panel Height And Width Is Adjustable.

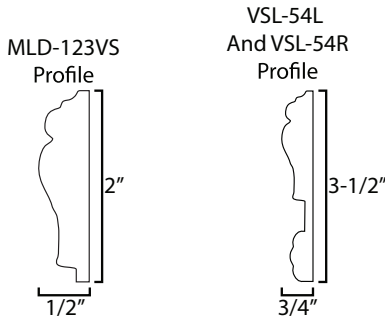

QTY	PART LIST	PRICE
4	CE-101	153.80
1	VSCT-54	329.95 Ea.
1	VSCT-54 EXT	75.90 Ea.
1	VS-54L	43.95 Ea.
1	VS-54R	43.95 Ea.
1	VSL-54L	230.95 Ea.
1	VSL-54R	230.95 Ea.
1	VSCB-54L	142.95 Ea.
1	VSCB-54R	142.95 Ea.
1	VSC-54	164.95 Ea.
25'	MLD-123VS	274.87
	Total Cost	1835.17

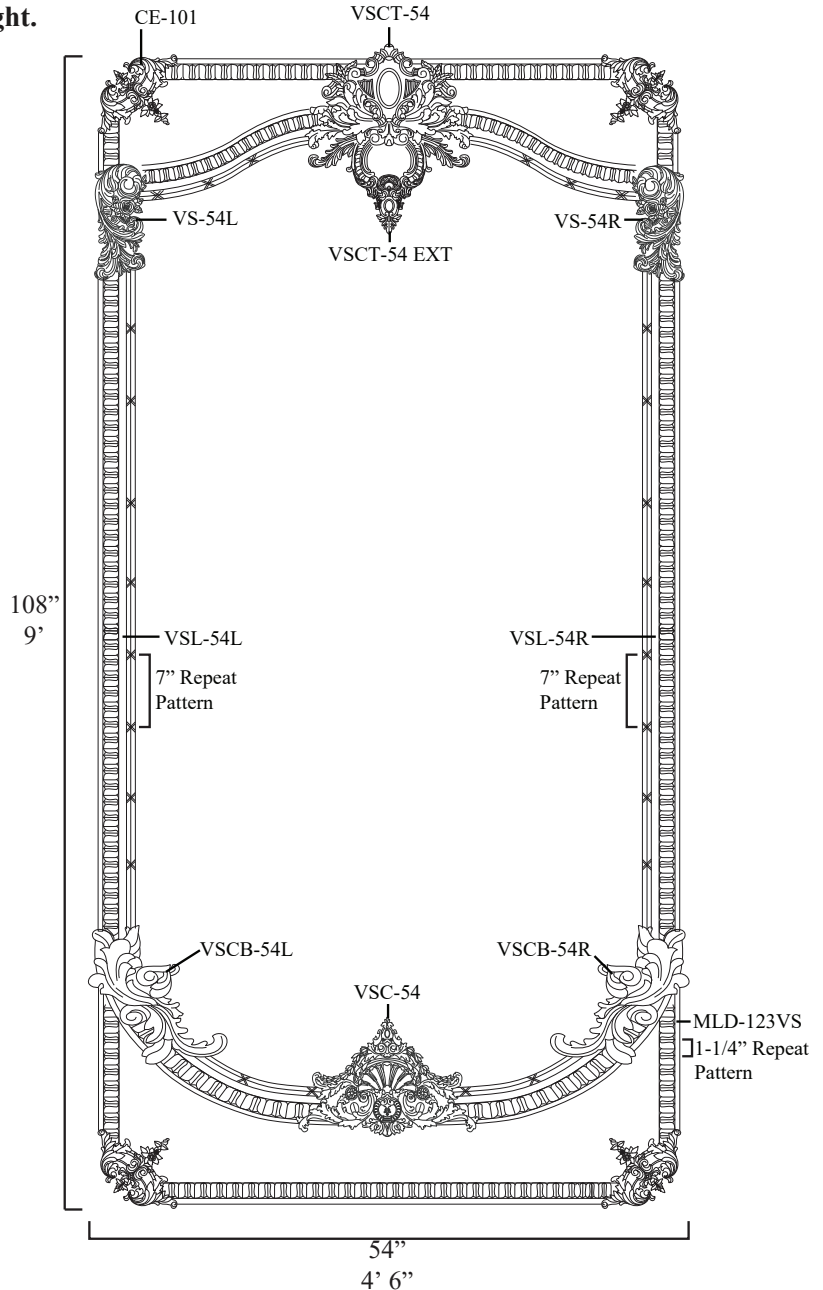

\*"THIS IS NOT A BUILD DRAWING". All drawings are "CONCEPT ONLY" and should be used as such.

\*Projects built from concept drawings will "ALWAYS" vary due to unforeseen installation and field measurement changes.

\* All sizes are approx.- max W" x max H" x Thickness"

# Wallpanels



[www.pearlworksinc.com](http://www.pearlworksinc.com)

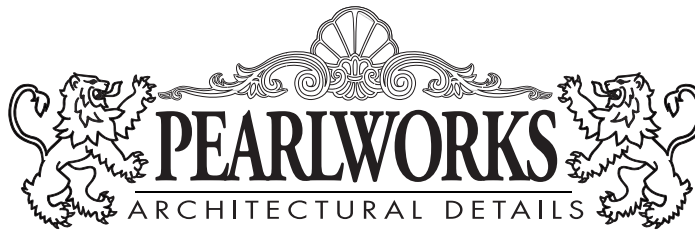

Toll Free: (855)-PEARLWORKS Website: pearlworksinc.com

WALLPANEL WP32-1A

- \*Panel Height And Width Is Adjustable.
- \*Price Can Vary Depending On Panel Height.
- \*Flexible Sub-Components Along With How You Lay Out The Design Allow Easy Adjustments To Width.
- \*Please Note All Written Measurements Are Approximate And Not Exact.

Exploded View

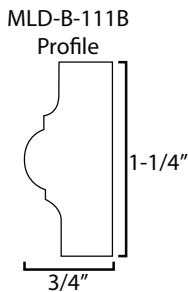
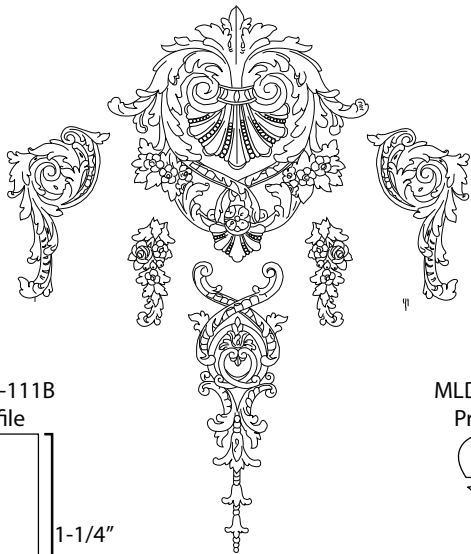

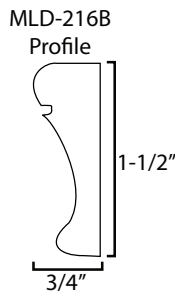

Connection Moulding

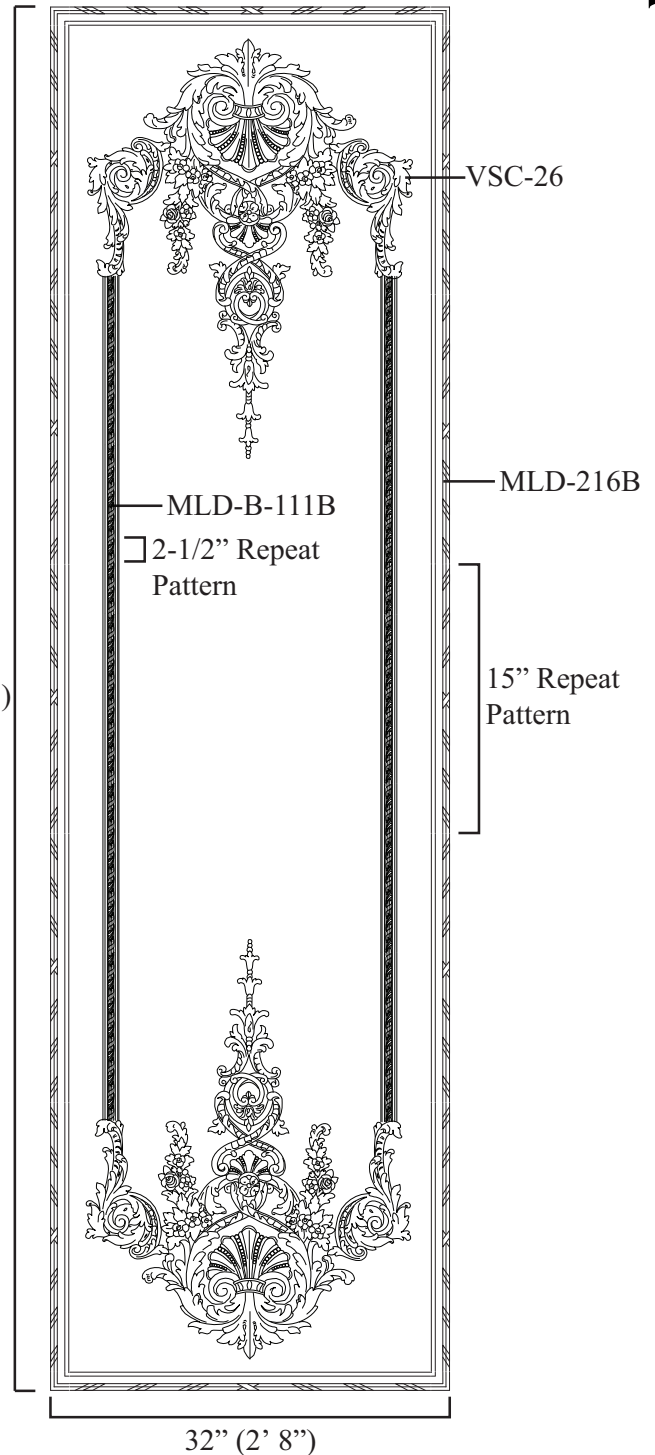

Connection Moulding

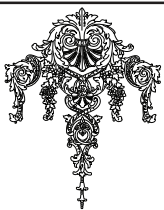

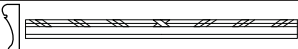
	QTY	PART LIST	PRICE
	2	VSC-26	519.90
	10'	MLD-B-111B	79.95
	25'	MLD-216B	208.90
		Total Cost	808.75

\*"THIS IS NOT A BUILD DRAWING". All drawings are "CONCEPT ONLY" and should be used as such.

\*Projects built from concept drawings will "ALWAYS" vary due to unforeseen installation and field measurement changes.

\* All sizes are approx.- max W" x max H" x Thickness"

## Versailles Side Panel



# Versailles Side Panel Components

The Versailles side wall panels were created using our modular system, which allows maximum design adjustability. Each of the 5 different component designs can be used in a wide variety of locations to create different looks and any height needed.

All of the designs that require connection moldings have built in attachment points which require no blending. This detail when installing saves hours of labor cost.

I urge you to compare these highly detailed carved side panels to anything on the market today. Not only are they the easiest components to install but they are easily stained or painted and can be applied to any flat or curved surface.

\* Each of the 5 versailles modular designs can be used in any combination and quantity to create any height required.

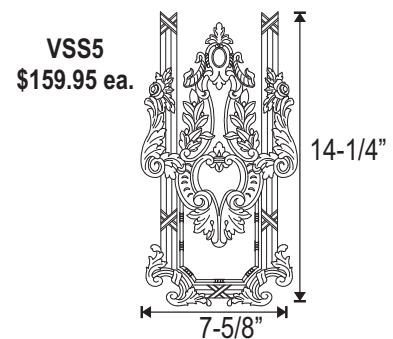
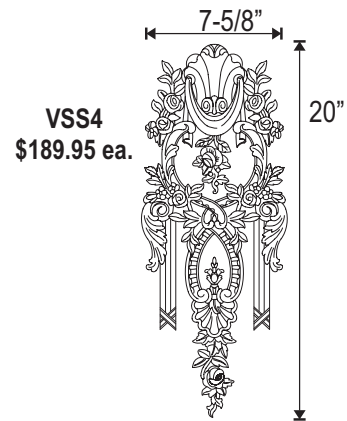
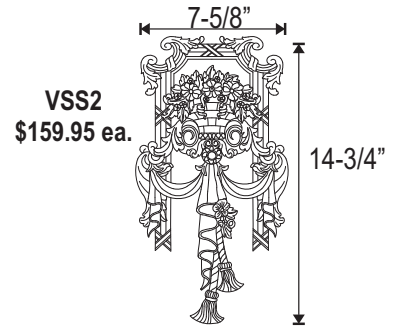
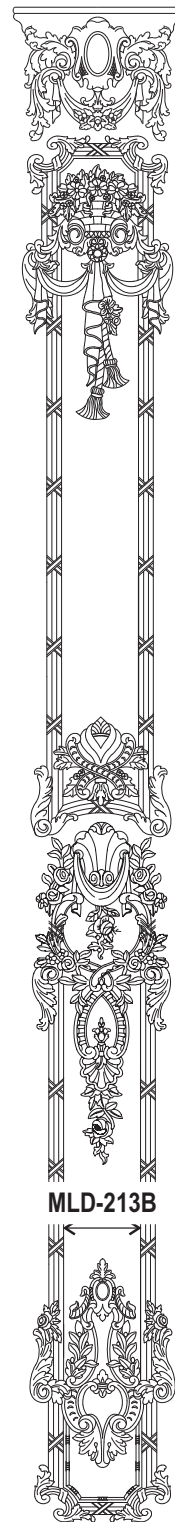

SIDE PANEL SET  
Total \$799.70 (as shown)  
Including 1 length of MLD-213B

\* Side Panel Thickness  
Varies from 1/2" to 1-1/2"

# Versailles Side Panel Combinations

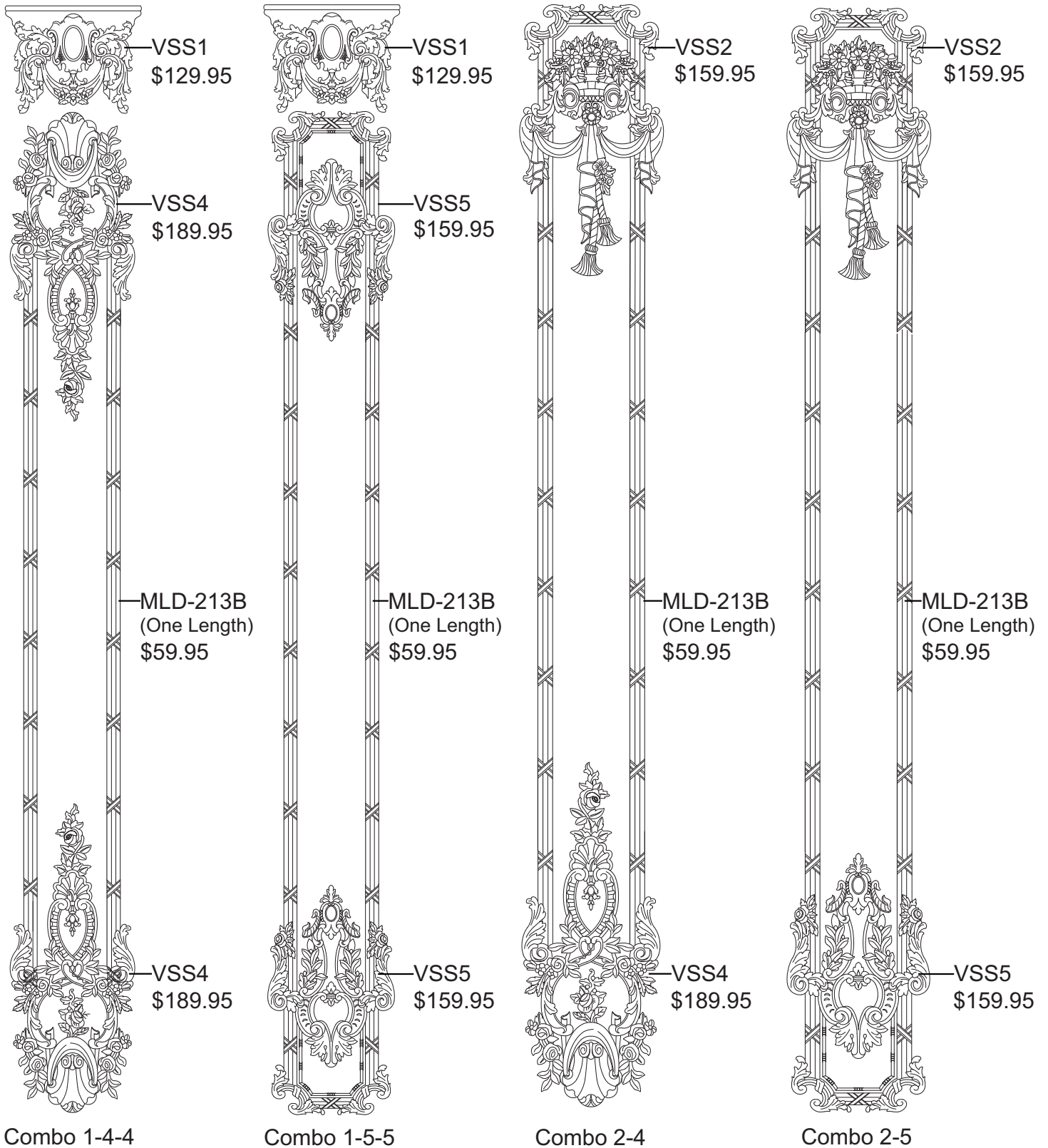

\* All drawings are conceptual designs. They are not "Build Drawings". Pearlworks recommends all clients check sizes and layouts before placing orders.

# Versailles Floral Detail



\* All sizes are approx.- max W" x max H" x Thickness"

# Precast Triple Moulding Wallpanel





Toll Free: (855)-PEARLWORKS Website: pearlworksinc.com

PRECAST WALLPANELWP15-ID

\*Please Note All Written Measurements Are Approximate And Not Exact.

\*Easy Adjustments To Height.

\*Price Can Vary Depending On Panel Height.

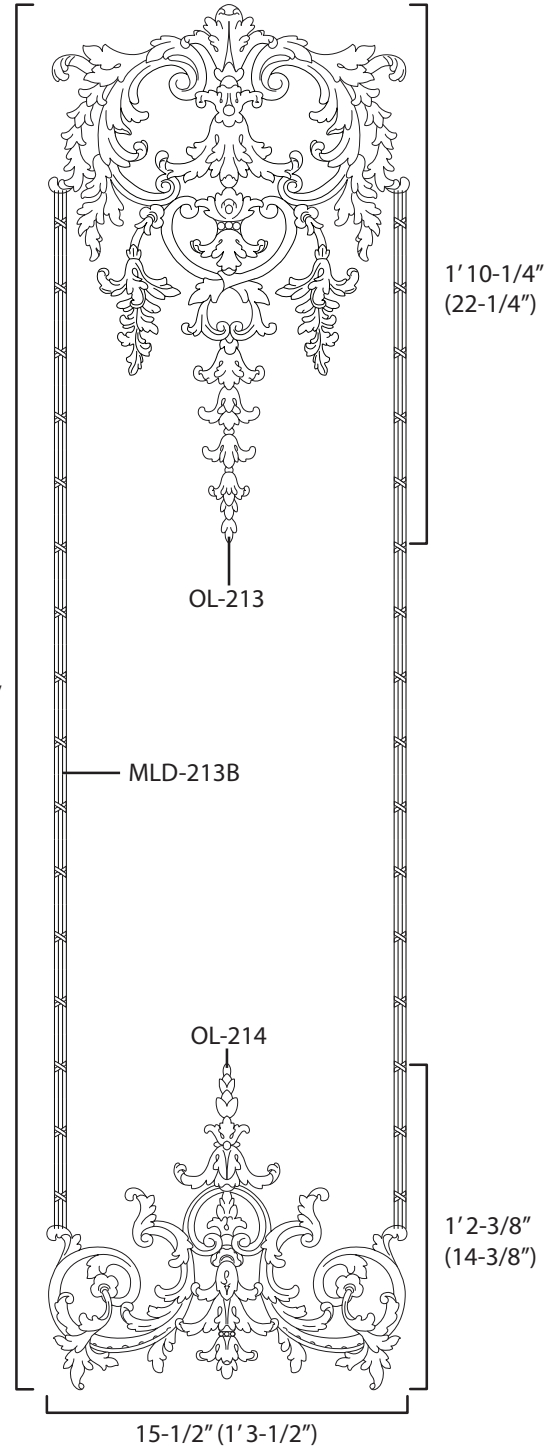
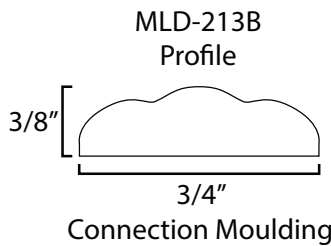
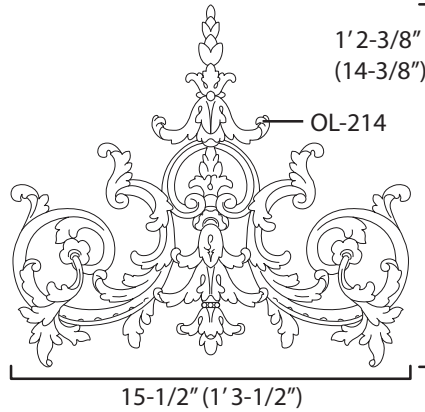
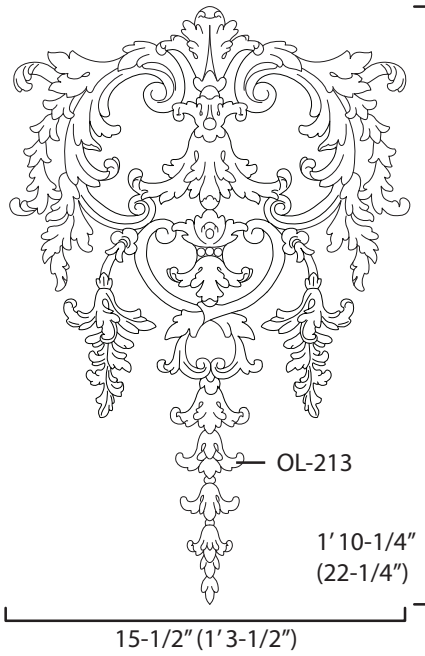

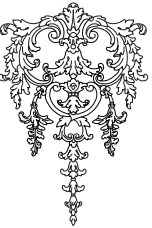
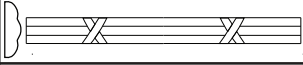
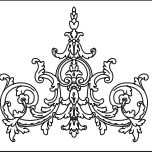
	QTY	PART LIST	PRICE
	1	OL-213	\$99.95
	1	MLD-213B	\$54.95
	1	OL-214	\$79.95
		Total Cost	\$234.85

\*"THIS IS NOT A BUILD DRAWING". All drawings are "CONCEPT ONLY" and should be used as such.

\*Projects built from concept drawings will "ALWAYS" vary due to unforeseen installation and field measurement changes.

\* All sizes are approx.- max W" x max H" x Thickness"

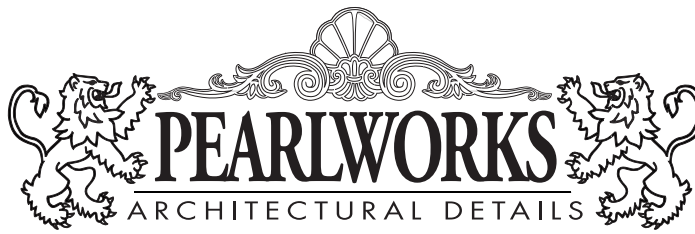

Toll Free: (855)-PEARLWORKS Website: pearlworksinc.com

PRECAST WALLPANEL WP24-1B

- \*Panel Height And Width Is Adjustable.
- \*Price Can Vary Depending On Panel Height.
- \*Flexible Sub-Components Along With How You Lay Out The Design Allow Easy Adjustments To Width.
- \*Please Note All Written Measurements Are Approximate And Not Exact.

Exploded View

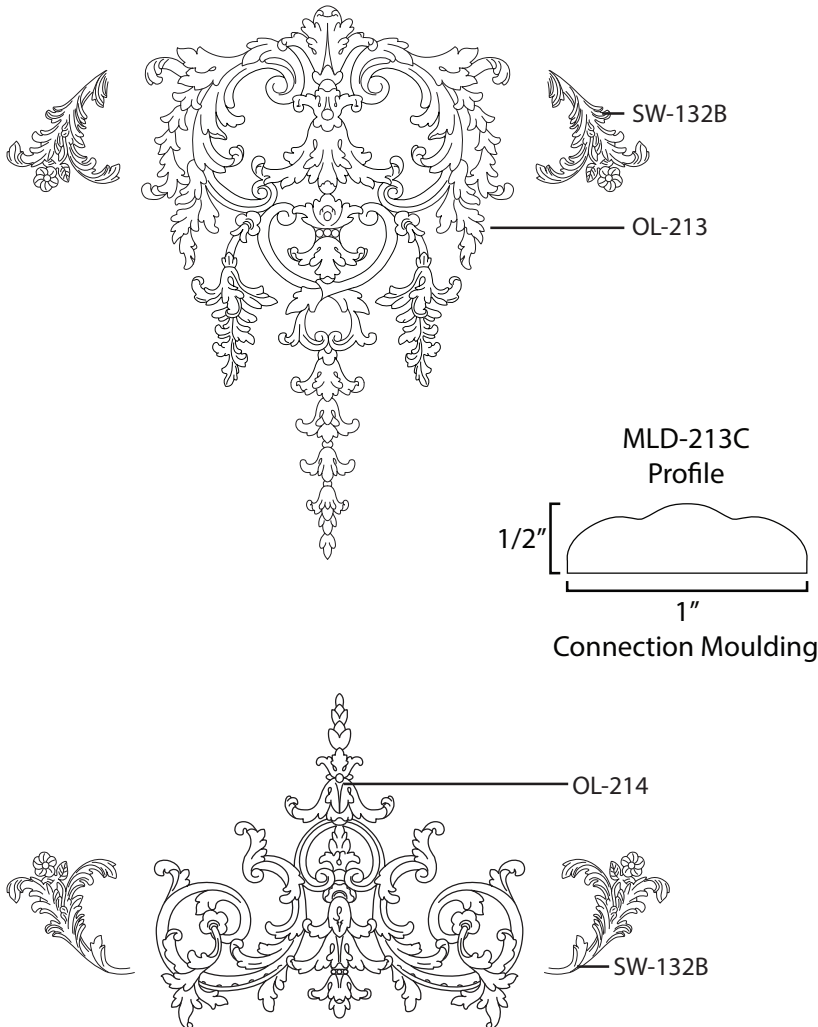

84"  
Approx.

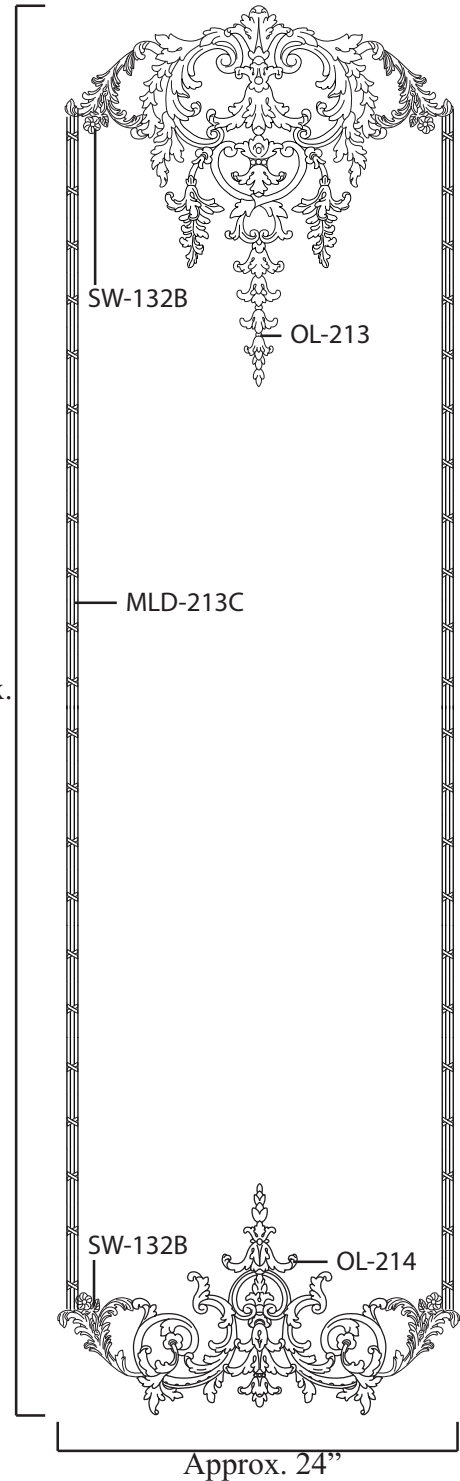

\*"THIS IS NOT A BUILD DRAWING". All drawings are "CONCEPT ONLY" and should be used as such.

\*Projects built from concept drawings will "ALWAYS" vary due to unforeseen installation and field measurement changes

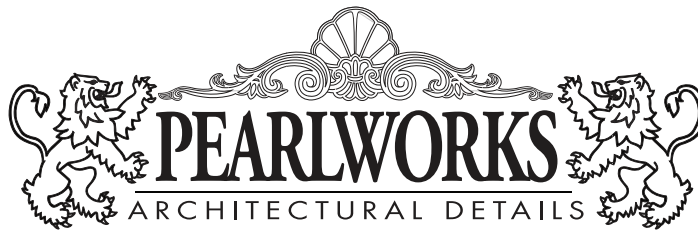

Toll Free: (855)-PEARLWORKS Website: pearlworksinc.com

PRECAST WALLPANEL WP15-1A

- \*Please Note All Written Measurements Are Approximate And Not Exact.
- \*Easy Adjustments To Height.
- \*Price Can Vary Depending On Panel Height.

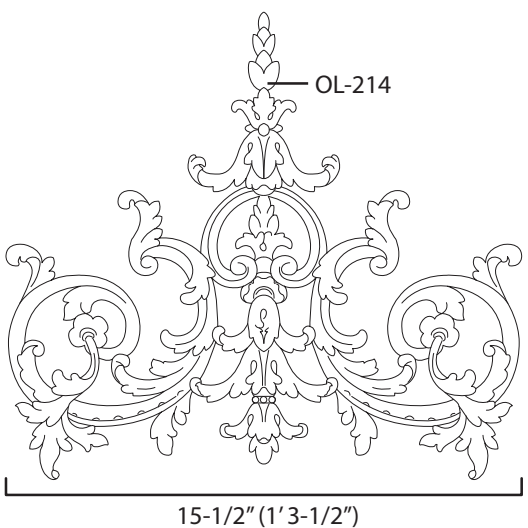
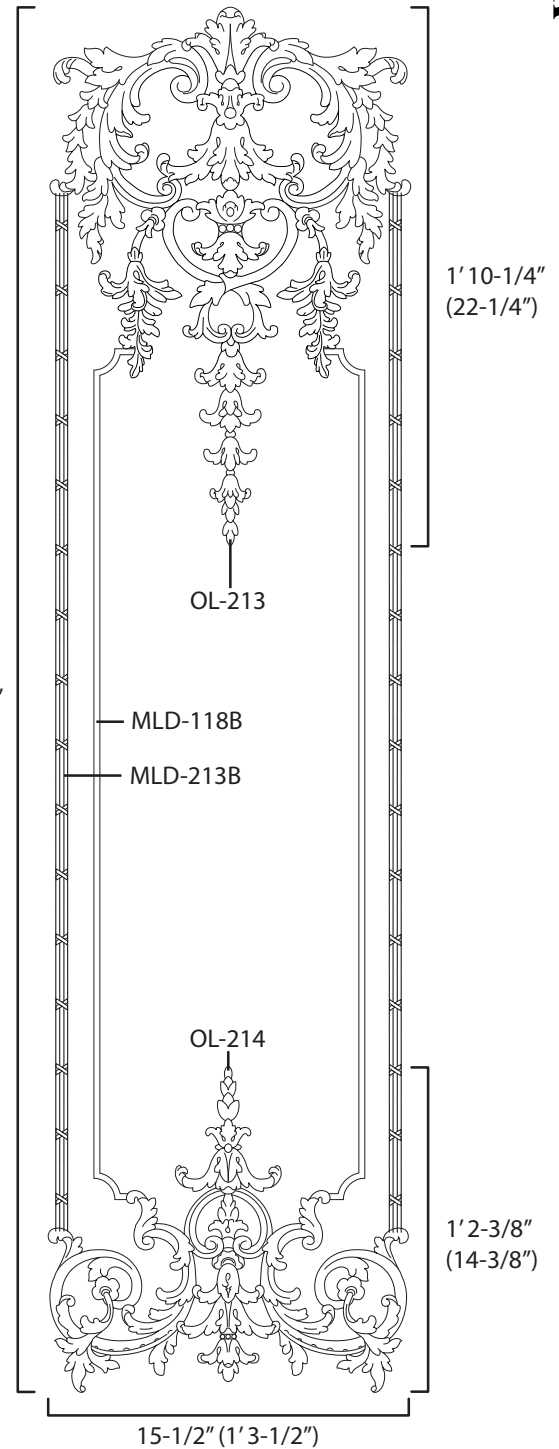
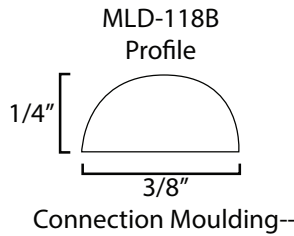
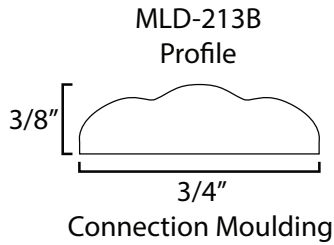
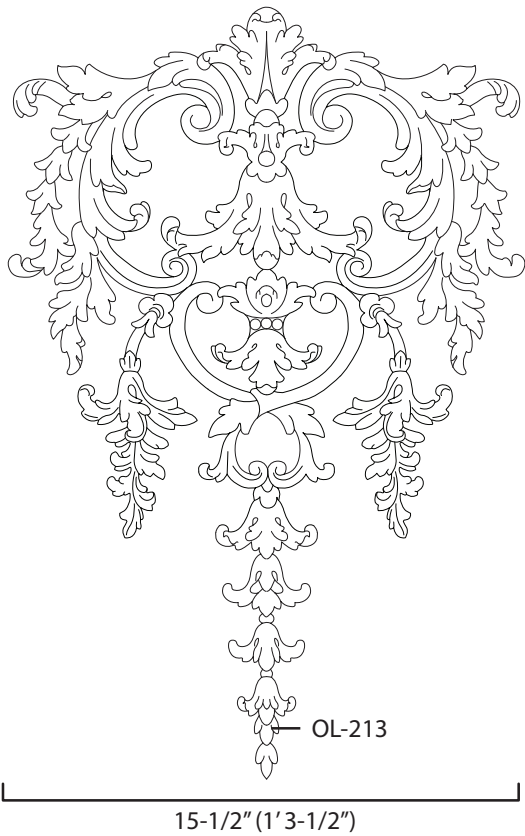

\*"THIS IS NOT A BUILD DRAWING". All drawings are "CONCEPT ONLY" and should be used as such.

\*Projects built from concept drawings will "ALWAYS" vary due to unforeseen installation and field measurement changes.

\* All sizes are approx.- max W" x max H" x Thickness"



Toll Free: (855)-PEARLWORKS Website: pearlworksinc.com

PRECAST WALLPANEL WP15-1C

\*Please Note All Written Measurements Are Approximate And Not Exact.

\*Easy Adjustments To Height.

\*Price Can Vary Depending On Panel Height.

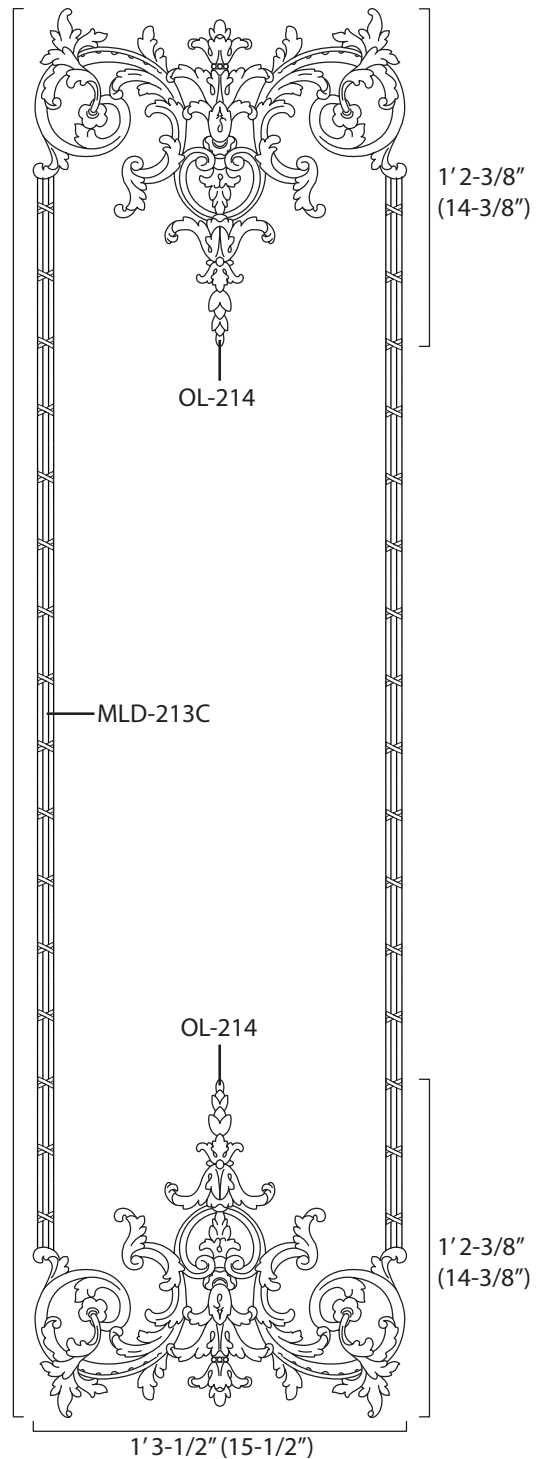
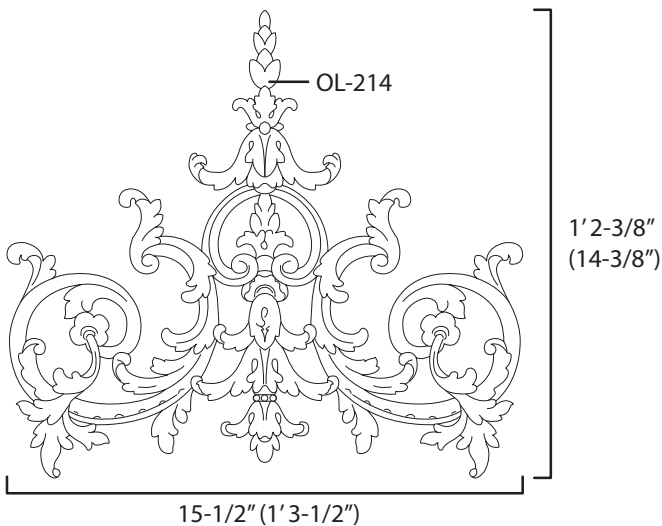
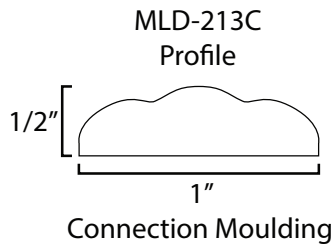
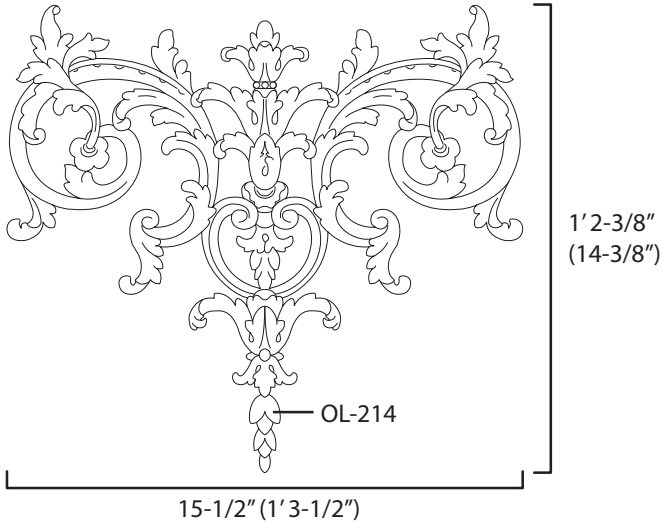

\*"THIS IS NOT A BUILD DRAWING". All drawings are "CONCEPT ONLY" and should be used as such.

\*Projects built from concept drawings will "ALWAYS" vary due to unforeseen installation and field measurement changes.

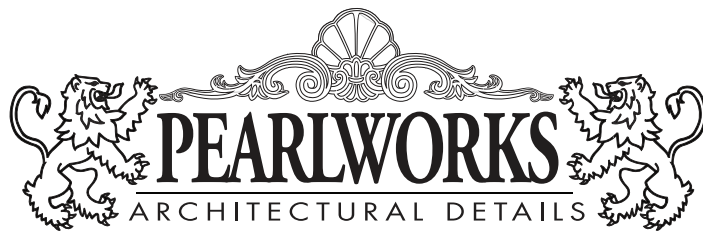

Toll Free: (855)-PEARLWORKS Website: pearlworksinc.com

PRECAST WALLPANEL WP15-1B

- \*Please Note All Written Measurements Are Approximate And Not Exact.
- \*Easy Adjustments To Height.
- \*Price Can Vary Depending On Panel Height.

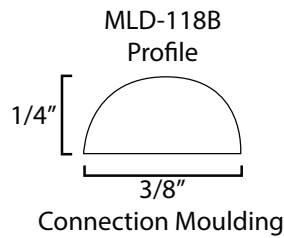
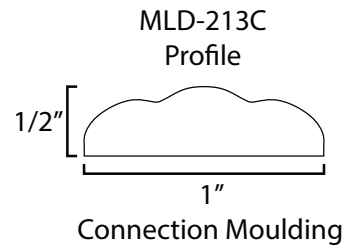
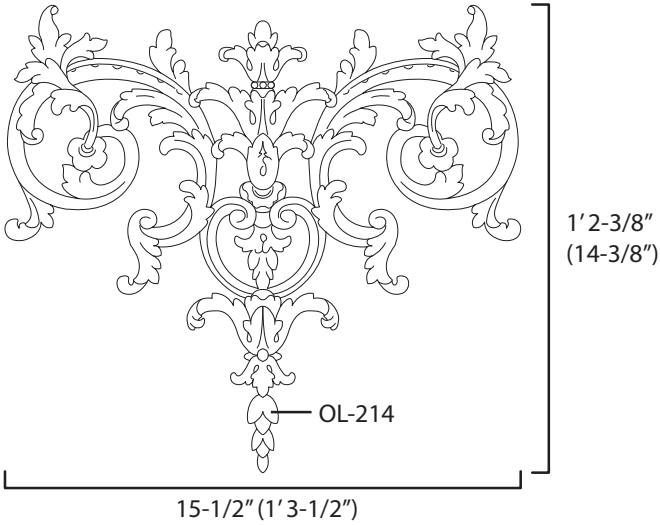

4'8-1/2" (56-1/2")

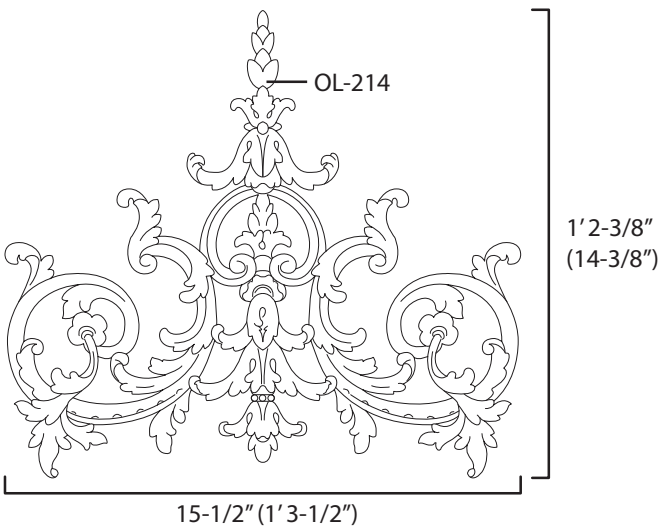
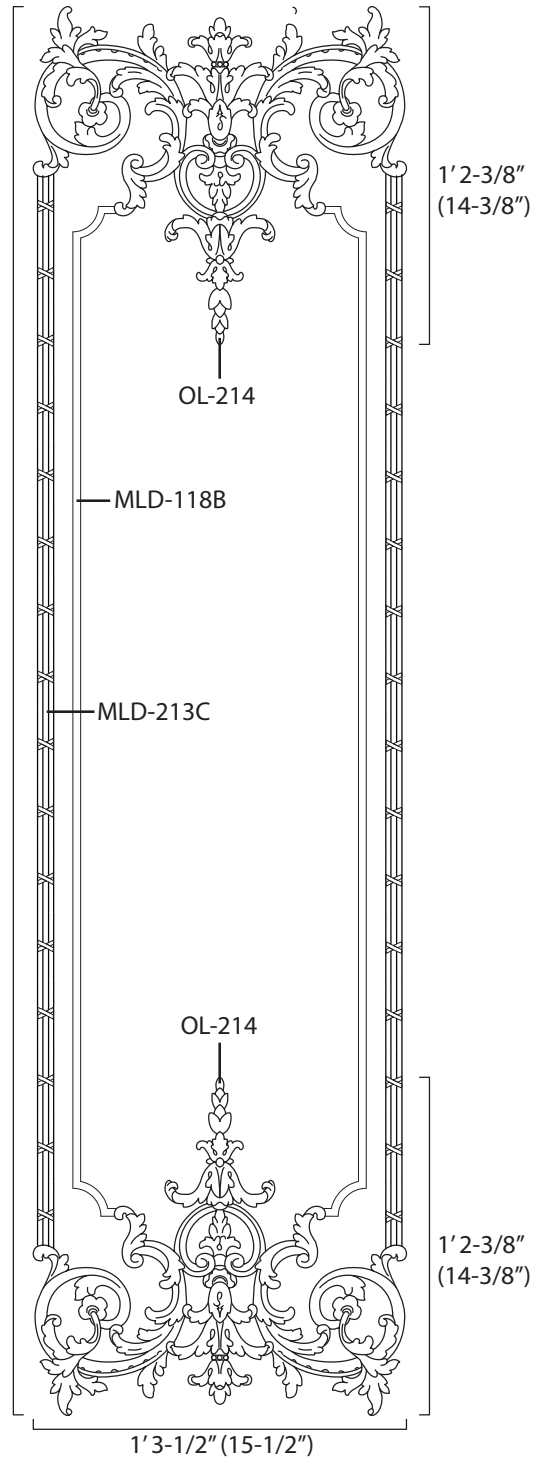

\*"THIS IS NOT A BUILD DRAWING". All drawings are "CONCEPT ONLY" and should be used as such.

\*Projects built from concept drawings will "ALWAYS" vary due to unforeseen installation and field measurement changes.

\* All sizes are approx.- max W" x max H" x Thickness"



Toll Free: (855)-PEARLWORKS Website: pearlworksinc.com

**FREESTYLE WALLPANEL WP40-1A**

- \*Panel Height And Width Is Adjustable.
- \*Price Can Vary Depending On Panel Height.
- \*Flexible Sub-Components Along With How You Lay Out The Design Allow Easy Adjustments To Width.
- \*Please Note All Written Measurements Are Approximate And Not Exact.

Exploded View

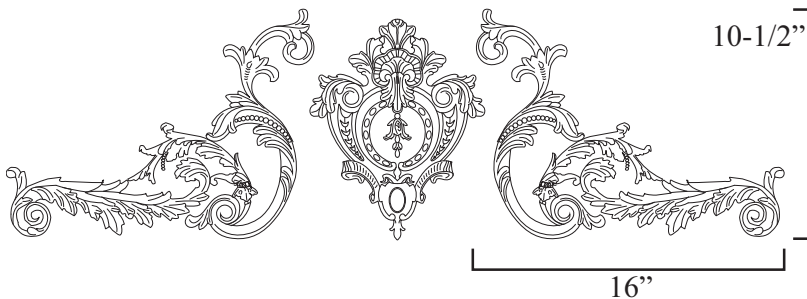

MLD-213C Profile

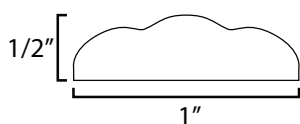

Connection Moulding

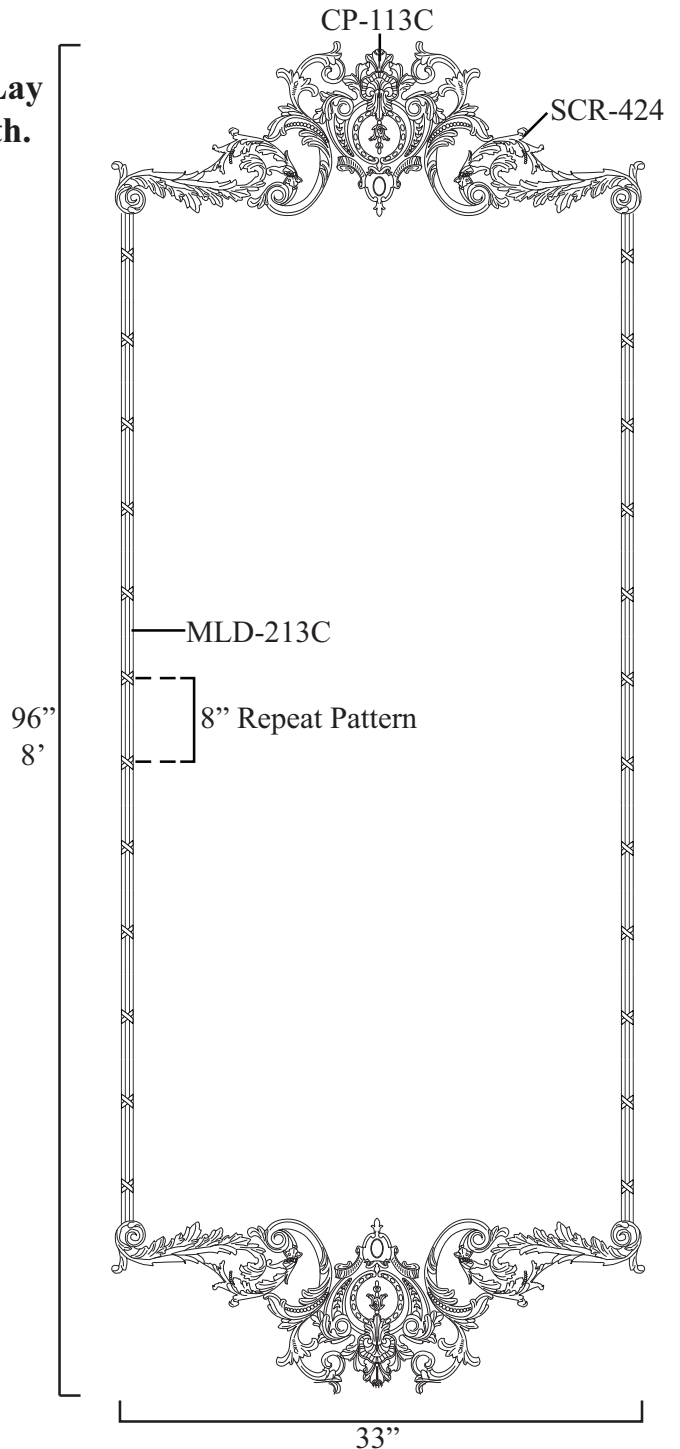

	QTY	PART LIST	PRICE
	2	CP-113C	79.90
	2	SCR-424	299.90
	12'	MLD-213C	69.95
		Total Cost	449.75

\*"THIS IS NOT A BUILD DRAWING". All drawings are "CONCEPT ONLY" and should be used as such.

\*Projects built from concept drawings will "ALWAYS" vary due to unforeseen installation and field measurement changes.



Toll Free: (855)-PEARLWORKS Website: pearlworksinc.com

FREESTYLE WALLPANEL WP40-1B

- \*Panel Height And Width Is Adjustable.
- \*Price Can Vary Depending On Panel Height.
- \*Flexible Sub-Components Along With How You Lay Out The Design Allow Easy Adjustments To Width.
- \*Please Note All Written Measurements Are Approximate And Not Exact.

Exploded View

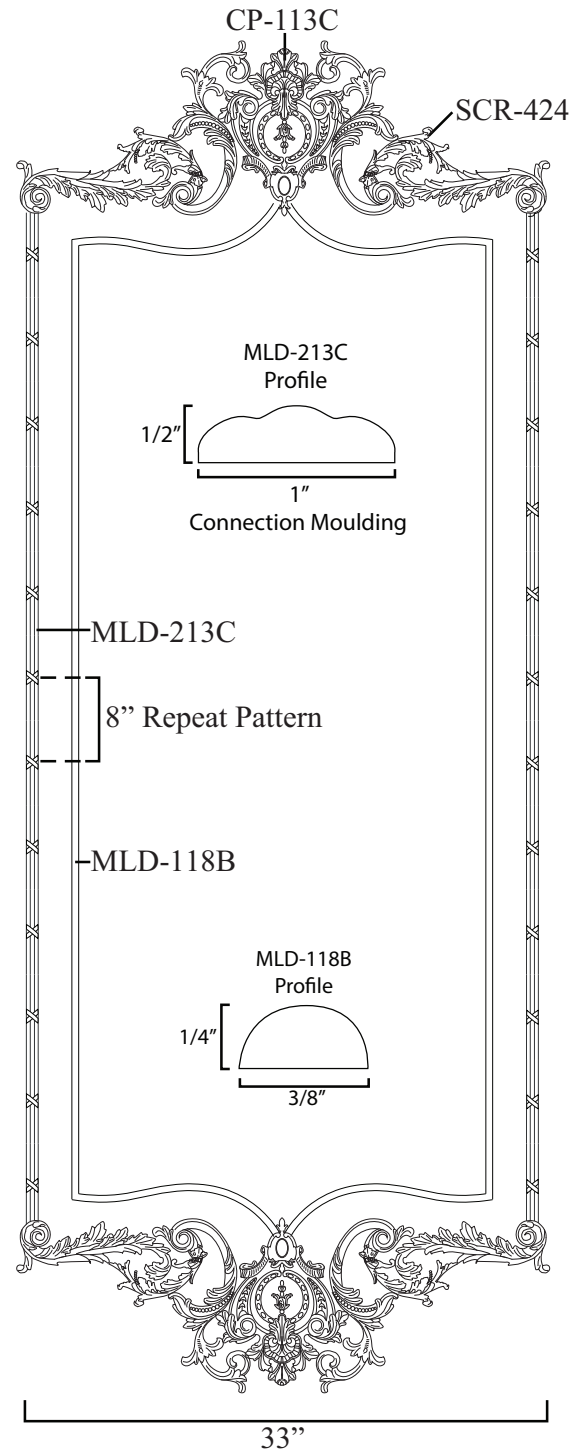

	QTY	PART LIST	PRICE
	2	CP-113C	79.90
	2	SCR-424	299.90
	12'	MLD-213C	69.95
	25'	MLD-118B	83.90
		Total Cost	533.65

\*"THIS IS NOT A BUILD DRAWING". All drawings are "CONCEPT ONLY" and should be used as such.

\*Projects built from concept drawings will "ALWAYS" vary due to unforeseen installation and field measurement changes.

\* All sizes are approx.- max W" x max H" x Thickness"



Toll Free: (855)-PEARLWORKS Website: pearlworksinc.com

FREESTYLE WALLPANEL WP40-1C

- \*Panel Height And Width Is Adjustable.
- \*Price Can Vary Depending On Panel Height.
- \*Flexible Sub-Components Along With How You Lay Out The Design Allow Easy Adjustments To Width.
- \*Please Note All Written Measurements Are Approximate And Not Exact.

Exploded View

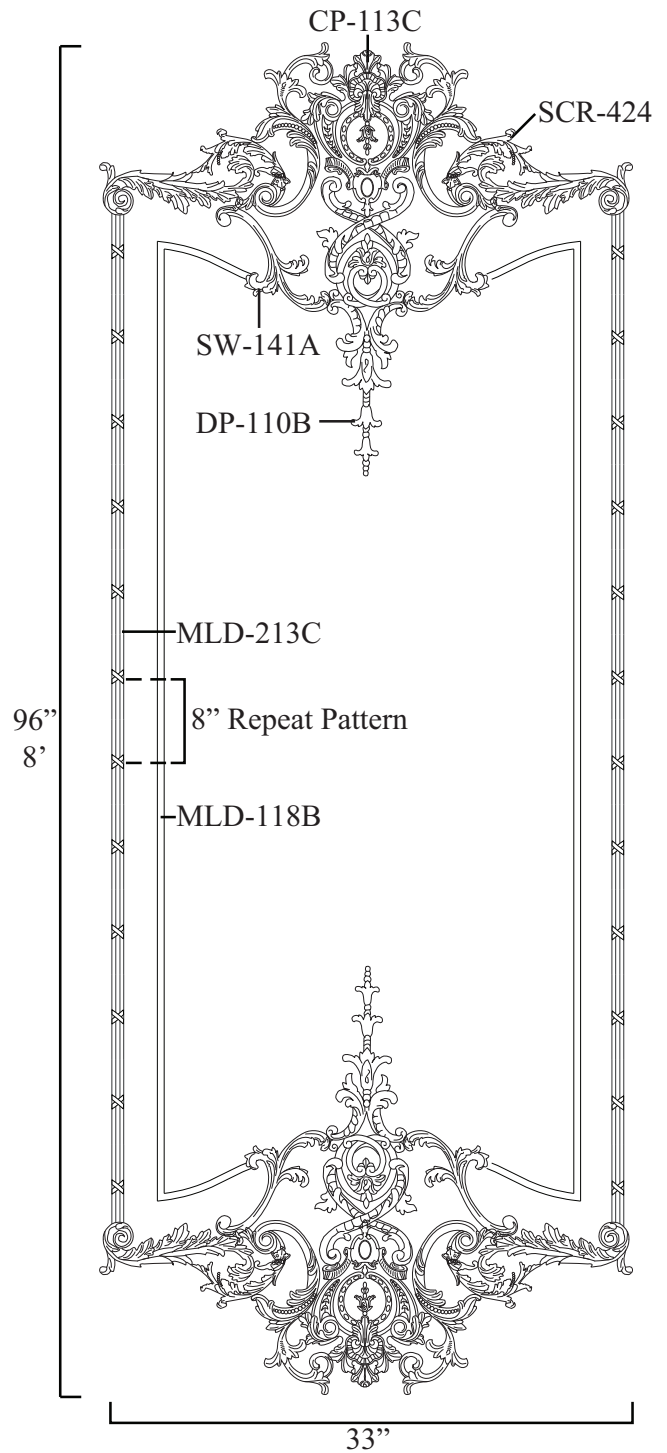
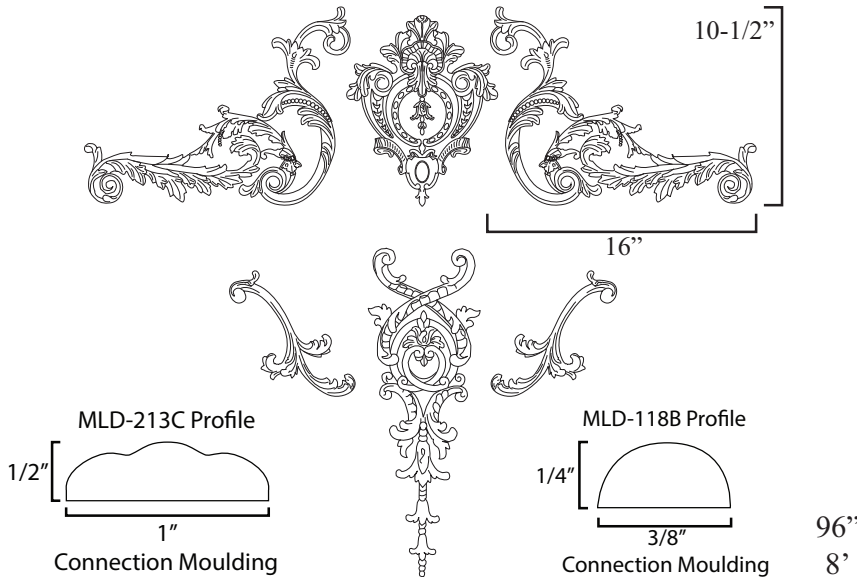

	QTY	PART LIST	PRICE
	2	CP-113C	79.90
	2	SCR-424	299.90
	2	SW-141A	39.90
	2	DP-110B	79.90
	12'	MLD-213C	69.95
	25'	MLD-118B	83.90
		Total Cost	653.45

\*"THIS IS NOT A BUILD DRAWING". All drawings are "CONCEPT ONLY" and should be used as such.

\*Projects built from concept drawings will "ALWAYS" vary due to unforeseen installation and field measurement changes.

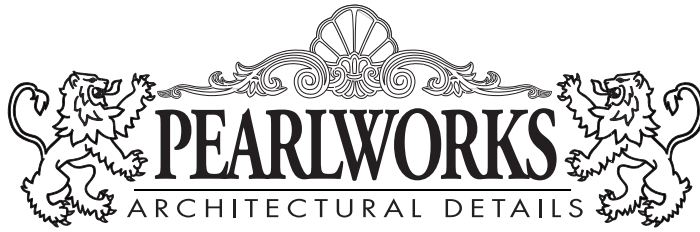

Toll Free: (855)-PEARLWORKS Website: pearlworksinc.com

PRECAST WALLPANEL WP40-1D

- \*Please Note All Written Measurements Are Approximate And Not Exact.
- \*Easy Adjustments To Height.
- \*Price Can Vary Depending On Panel Height.

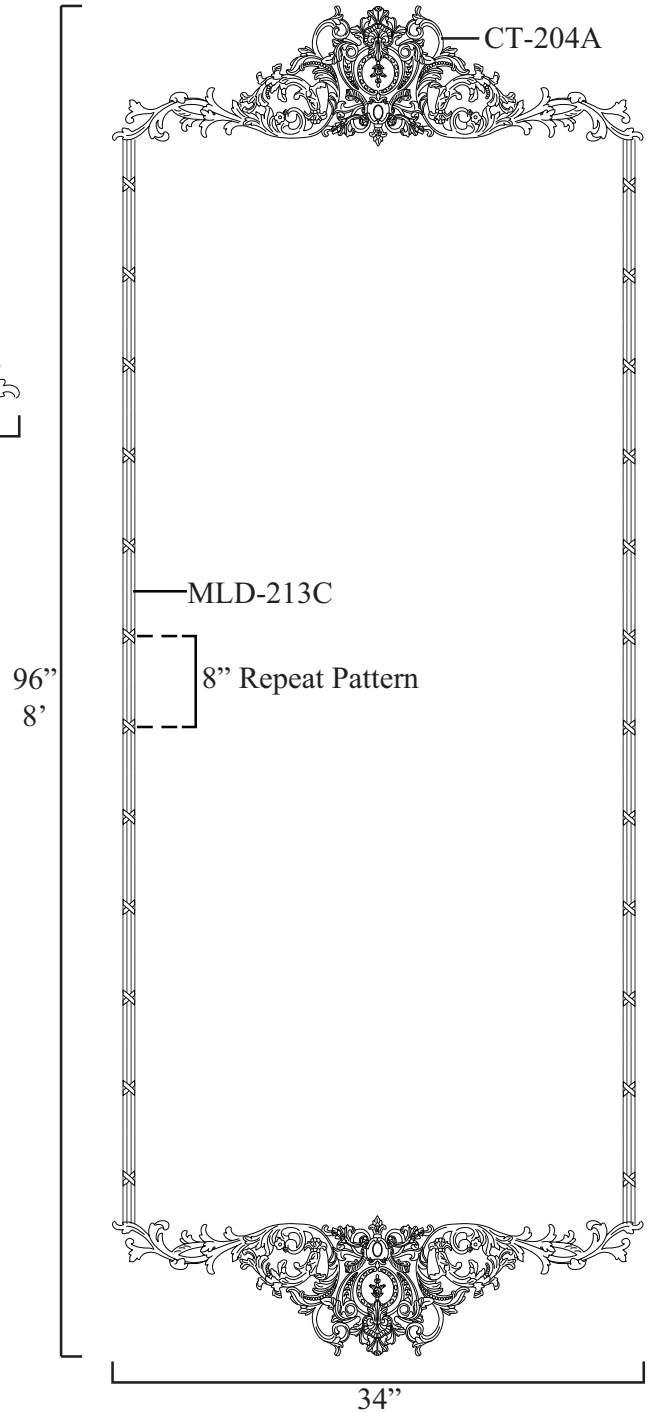
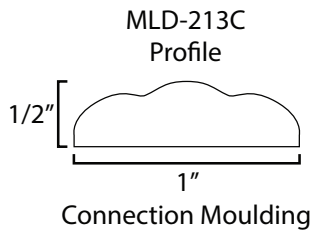
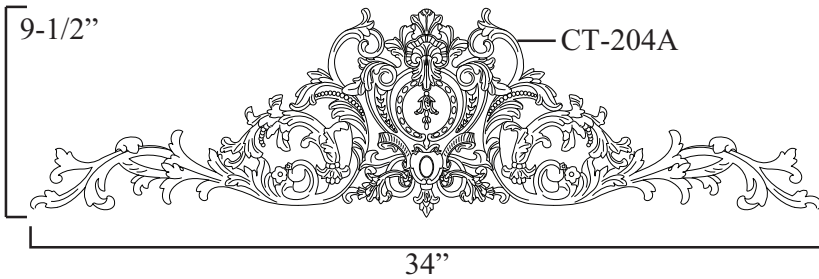

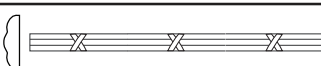
	QTY	PART LIST	PRICE
	2	CT-204A	339.90
	12'	MLD-213C	69.95
		Total Cost	409.85

\*"THIS IS NOT A BUILD DRAWING". All drawings are "CONCEPT ONLY" and should be used as such.

\*Projects built from concept drawings will "ALWAYS" vary due to unforeseen installation and field measurement changes.

\* All sizes are approx.- max W" x max H" x Thickness"

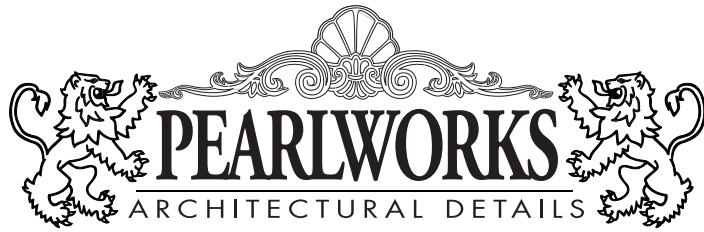

Toll Free: (855)-PEARLWORKS Website: pearlworksin.com

PRECAST WALLPANEL WP40-1E

\*Please Note All Written Measurements Are Approximate And Not Exact.

\*Easy Adjustments To Height.

\*Price Can Vary Depending On Panel Height.

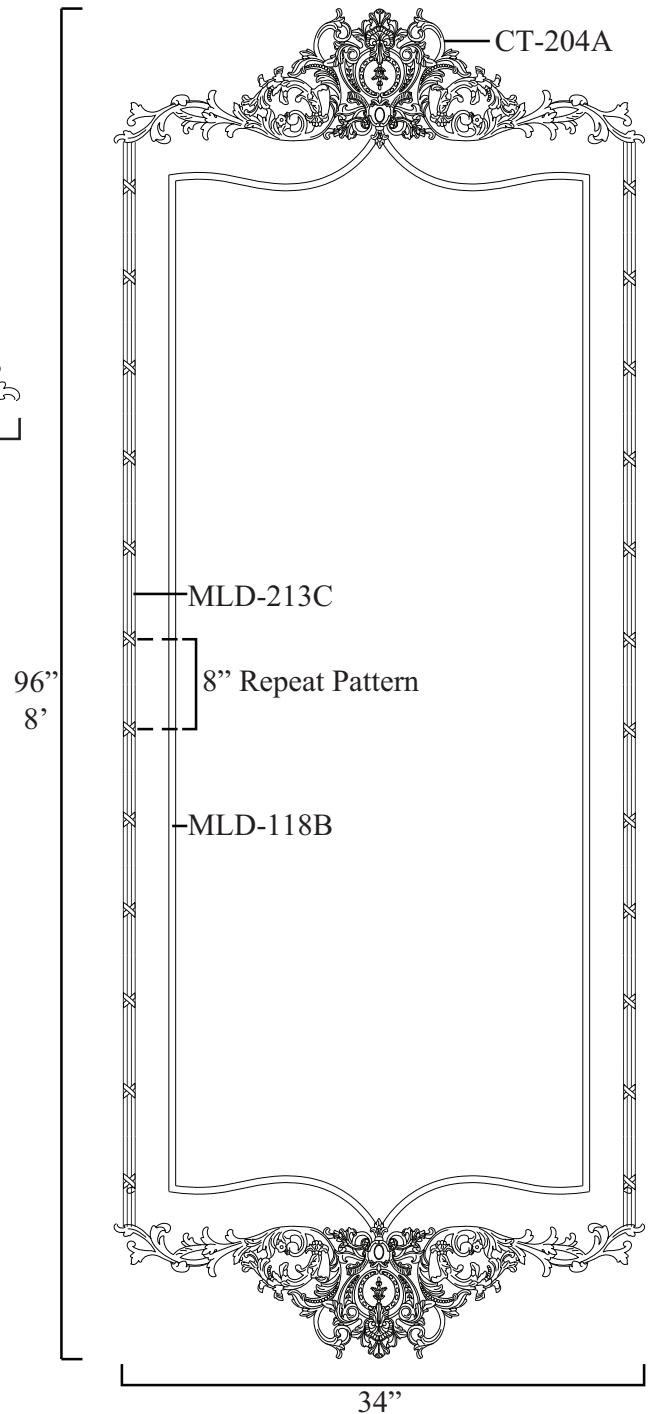
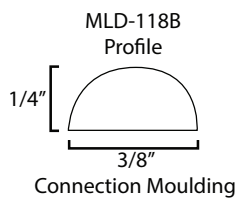
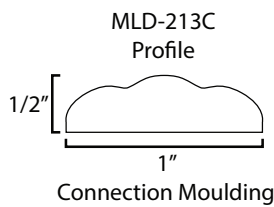
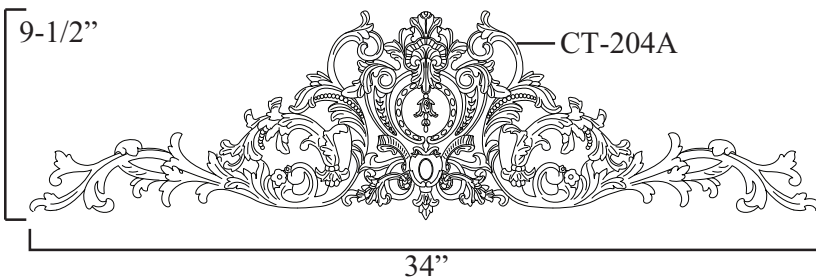

	QTY	PART LIST	PRICE
	2	CT-204A	339.90
	12'	MLD-213C	69.95
	25'	MLD-118B	83.90
		Total Cost	493.75

\*"THIS IS NOT A BUILD DRAWING". All drawings are "CONCEPT ONLY" and should be used as such.

\*Projects built from concept drawings will "ALWAYS" vary due to unforeseen installation and field measurement changes.

\* All sizes are approx.- max W" x max H" x Thickness"



Toll Free: (855)-PEARLWORKS Website: pearlworksinc.com

PRECAST WALLPANEL WP40-1F

- \*Please Note All Written Measurements Are Approximate And Not Exact.
- \*Easy Adjustments To Height.
- \*Price Can Vary Depending On Panel Height.

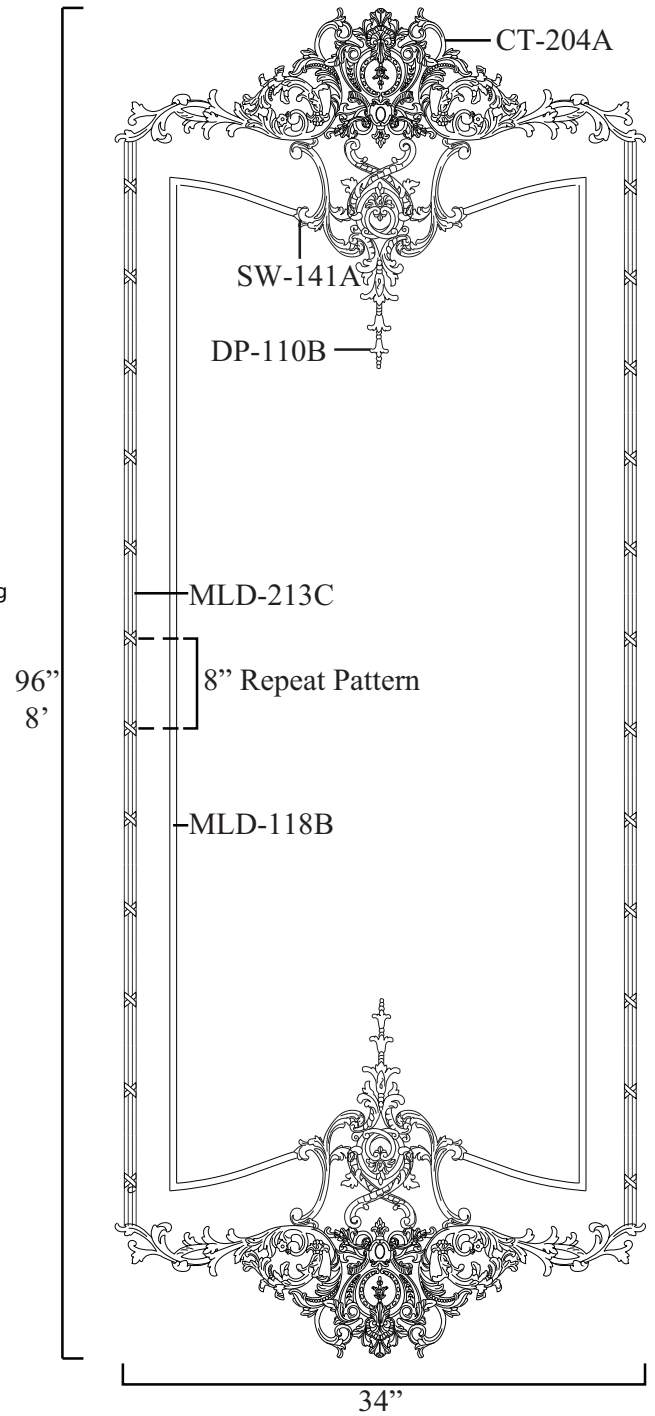
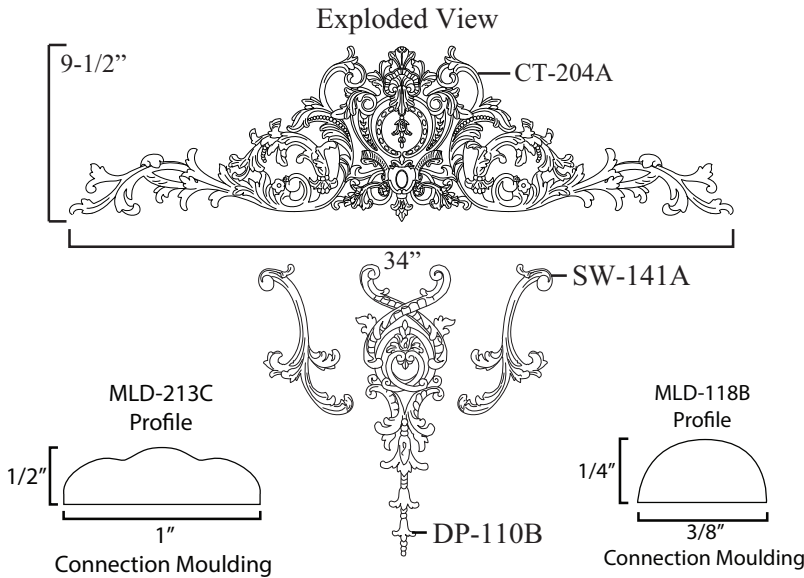

	QTY	PART LIST	PRICE
	2	CT-204A	339.90
	2	DP-110B	79.90
	2	SW-141A	39.90
	12'	MLD-213C	69.95
	25'	MLD-118B	83.90
		Total Cost	613.55

\*"THIS IS NOT A BUILD DRAWING". All drawings are "CONCEPT ONLY" and should be used as such.

\*Projects built from concept drawings will "ALWAYS" vary due to unforeseen installation and field measurement changes.

\* All sizes are approx.- max W" x max H" x Thickness"

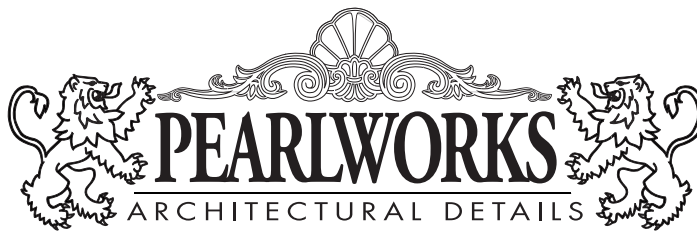

Toll Free: (855)-PEARLWORKS Website: pearlworksinc.com

FREESTYLE WALLPANEL WP58-1A

- \*Panel Height And Width Is Adjustable.
- \*Price Can Vary Depending On Panel Height.
- \*Flexible Sub-Components Along With How You Lay Out The Design Allow Easy Adjustments To Width.
- \*Please Note All Written Measurements Are Approximate And Not Exact.

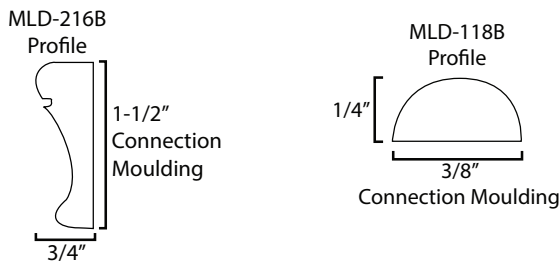

	QTY	PART LIST	PRICE
	2	CP-136	199.90
	2 Pair	SCR-200	339.90
	2 Pair	SW-140B	119.90
	2 Pair	SCR-100	79.90
	2	DP-110C	159.90
	15'	MLD-216B	128.95
	20'	MLD-118B	59.90
		Total Cost	1088.35

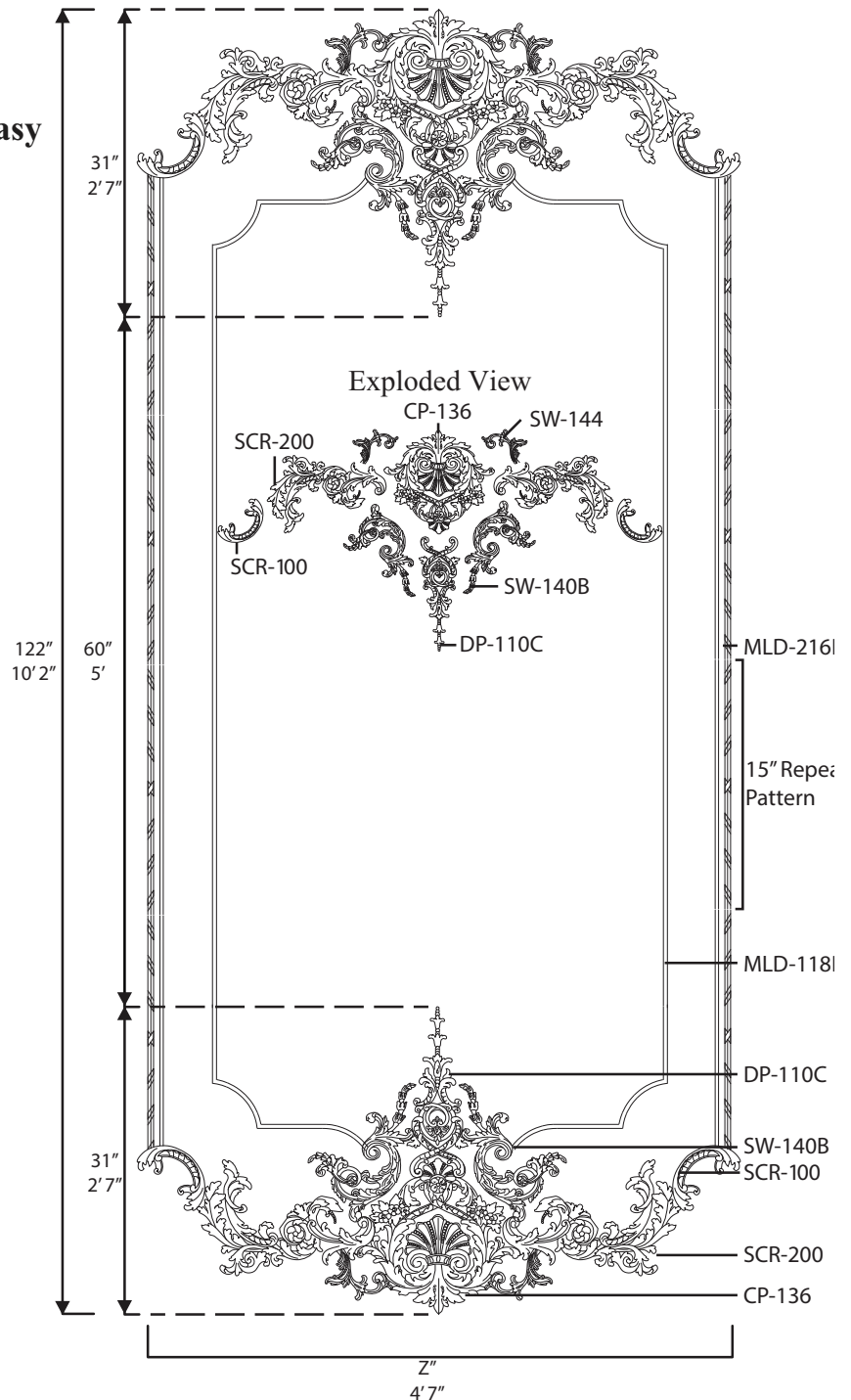

\*"THIS IS NOT A BUILD DRAWING". All drawings are "CONCEPT ONLY" and should be used as such.

\*Projects built from concept drawings will "ALWAYS" vary due to unforeseen installation and field measurement changes.

# Custom Freestyle Wallpanels



Custom wall panels can be created by using any number of components to create a top and bottom wall panel header. CP-217A is a single casting with additional scrolls added to create the attachment point for connection mouldings.

CP-217A comes in three additional sizes for added versatility which can not only create different sized wall panels and ceilings as well.



CP-217



\* All sizes are approx. - max W" x max H" x Thickness"

# Custom Freestyle Wallpanel



# FreeStyle Part Designs

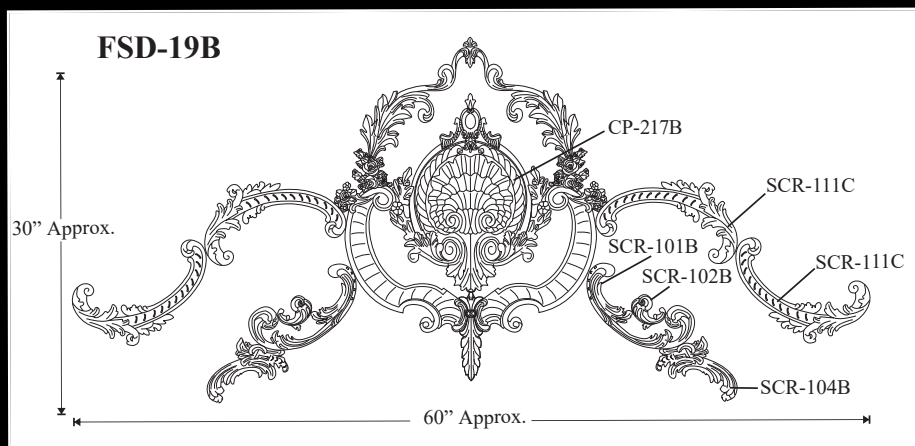
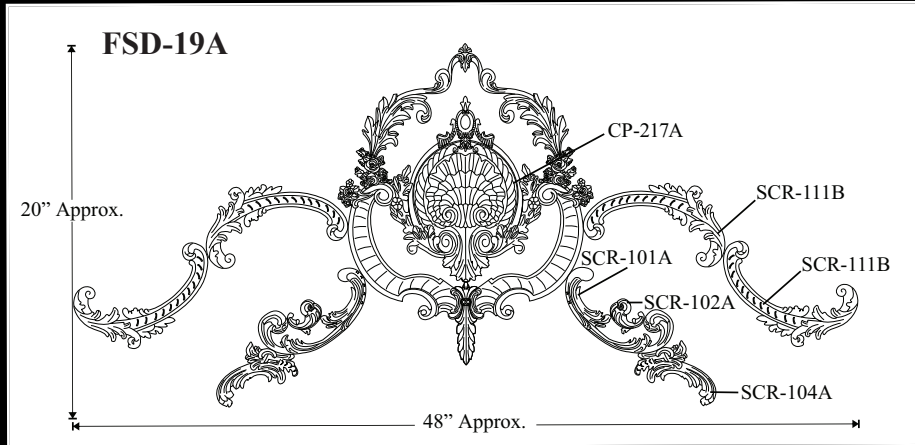
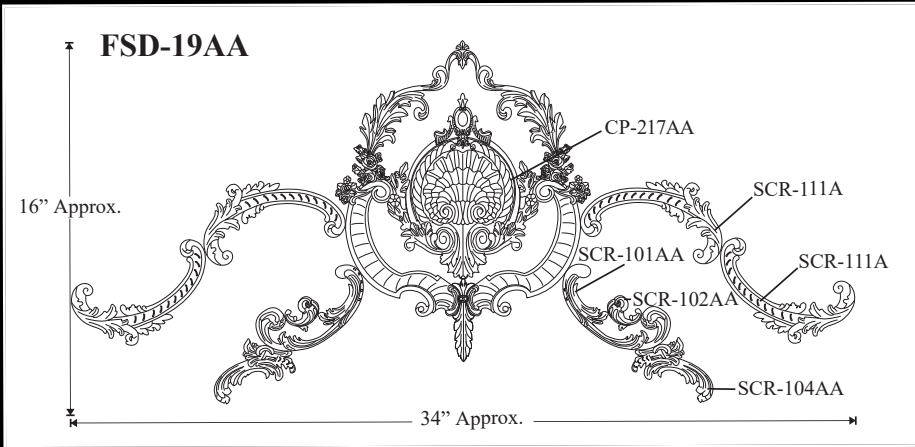

**CP-217AA**  
13-1/2" x 16" x 1"

**CP-217A**  
17" x 21" x 1-1/2"

**CP-217B**  
21" x 26" x 1-1/2"

# Wallpanels

